

# **Agilent 6200 Series TOF and 6500 Series Q-TOF LC/MS System**

## **Concepts Guide**

### **The Big Picture**



**Agilent Technologies**

# Notices

© Agilent Technologies, Inc. 2011

No part of this manual may be reproduced in any form or by any means (including electronic storage and retrieval or translation into a foreign language) without prior agreement and written consent from Agilent Technologies, Inc. as governed by United States and international copyright laws.

## Manual Part Number

G3335-90116

## Edition

Revision A, December 2011

Printed in USA

Agilent Technologies, Inc.  
5301 Stevens Creek Blvd.  
Santa Clara, CA 95051

Microsoft®, Windows® and Excel® are registered trademarks of Microsoft Corporation in the US and/or other countries.

## Software Revision

This guide applies to the Agilent MassHunter Workstation Software – Data Acquisition program for TOF and Q-TOF version B.05.00 or higher until superseded.

## Warranty

**The material contained in this document is provided “as is,” and is subject to being changed, without notice, in future editions. Further, to the maximum extent permitted by applicable law, Agilent disclaims all warranties, either express or implied, with regard to this manual and any information contained herein, including but not limited to the implied warranties of merchantability and fitness for a particular purpose. Agilent shall not be liable for errors or for incidental or consequential damages in connection with the furnishing, use, or performance of this document or of any information contained herein. Should Agilent and the user have a separate written agreement with warranty terms covering the material in this document that conflict with these terms, the warranty terms in the separate agreement shall control.**

## Technology Licenses

The hardware and/or software described in this document are furnished under a license and may be used or copied only in accordance with the terms of such license.

## Restricted Rights Legend

U.S. Government Restricted Rights. Software and technical data rights granted to the federal government include only those rights customarily provided to end user customers. Agilent provides this customary commercial license in Software and technical data pursuant to FAR 12.211 (Technical Data) and 12.212 (Computer Software) and, for the Department of Defense, DFARS 252.227-7015 (Technical Data - Commercial Items) and DFARS 227.7202-3 (Rights in Commercial Computer Software or Computer Software Documentation).

## Safety Notices

### CAUTION

A **CAUTION** notice denotes a hazard. It calls attention to an operating procedure, practice, or the like that, if not correctly performed or adhered to, could result in damage to the product or loss of important data. Do not proceed beyond a **CAUTION** notice until the indicated conditions are fully understood and met.

---

### WARNING

A **WARNING** notice denotes a hazard. It calls attention to an operating procedure, practice, or the like that, if not correctly performed or adhered to, could result in personal injury or death. Do not proceed beyond a **WARNING** notice until the indicated conditions are fully understood and met.

---

## In This Guide...

The *Concepts Guide* presents “The Big Picture” behind the Agilent TOF and Q-TOF LC/MS system to help you analyze samples on your Agilent time-of-flight or quadrupole time-of-flight mass spectrometer system. This guide helps you understand how the hardware and software work together.

### 1 Overview

Learn how the Agilent 6200 Series TOF and 6500 Series Q-TOF LC/MS system helps you do your job and how the hardware and software work.

### 2 Instrument Preparation

Learn the concepts you need to prepare the instrument for sample acquisition.

### 3 Methods with Acquisition Parameters

Learn concepts to help you enter instrument control parameter values and set up methods with acquisition parameters.

### 4 Data Acquisition

Learn concepts to help you enter information to run individual samples or a worklist of samples, and to help you acquire data and monitor runs.



# Contents

## 1 Overview

How does the TOF and Q-TOF system help you do your job?	10
Help for applications	11
Help for data acquisition	11
Help for data analysis	13
How do different ion sources work?	16
Electrospray ionization (ESI) and Dual ESI	17
Dual Agilent Jet Stream Electrospray Ionization (Dual AJS ESI)	21
Atmospheric pressure chemical ionization (APCI)	22
Atmospheric pressure photoionization (APPI)	24
Multimode ionization (MMI)	25
HPLC-Chip	27
How does the Agilent TOF and Q-TOF mass spectrometer work?	28
Innovative Enhancements in the Agilent 6550 iFunnel Q-TOF	31
Innovative Enhancements in the 6540 and 6538 Q-TOF	33
Innovative Enhancements in the 6530 Q-TOF	35
Agilent Jet Stream Thermal Gradient Technology	36
Front-end ion optics	38

## 2 Instrument Preparation

LC preparation	46
LC module setup	46
Column equilibration and conditioning	48
TOF and Q-TOF preparation – calibration and tuning	51
TOF mass calibration	51
Tuning choices	53
Tune reports	59

Storage and retrieval of tune results and Instrument Mode	60
Tune Set Point Modifications for Medium and Large Proteins	62
Real-time displays	63
Instrument Status Window	63
Real-time parameter values (Actuals)	64
Real-time Chromatogram Plot and Spectral Plot windows	66
System logbook	68

### 3 Methods with Acquisition Parameters

Parameter entry	72
LC parameter entry	72
TOF and Q-TOF parameter entry	72
Automatic TOF and Q-TOF parameter changes during a run	73
General TOF and Q-TOF parameters	76
Ion source parameters	76
TOF and Q-TOF acquisition parameters	79
Setup of TOF and Q-TOF reference mass correction (recalibration)	86
TOF and Q-TOF chromatogram setup	90
Method saving, editing and reporting	91
Saving a method with data acquisition parameters	91
Method editing	93
Method reporting	94

### 4 Data Acquisition

Interactive single sample setup	96
Sample information	96
Data File information	97
Some of the Additional Information parameters	97
Worklist setup	98
Worklist menus	99

Sample entry	100
Script entry	102
Entry of additional sample information (show, add columns)	103
Worklist import	104
Report setup	108
Run setup	109
Estimate of worklist file size	110
Data acquisition for samples and worklists	114
What you can monitor during a run	114
What you can do during a run	115





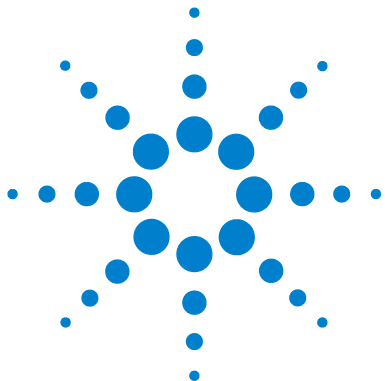

# 1 Overview

- How does the TOF and Q-TOF system help you do your job? 10
  - Help for applications 11
  - Help for data acquisition 11
  - Help for data analysis 13
- How do different ion sources work? 16
  - Electrospray ionization (ESI) and Dual ESI 17
  - Dual Agilent Jet Stream Electrospray Ionization (Dual AJS ESI) 21
  - Atmospheric pressure chemical ionization (APCI) 22
  - Atmospheric pressure photoionization (APPI) 24
  - Multimode ionization (MMI) 25
  - HPLC-Chip 27
- How does the Agilent TOF and Q-TOF mass spectrometer work? 28
  - Innovative Enhancements in the 6540 and 6538 Q-TOF 33
  - Innovative Enhancements in the 6530 Q-TOF 35
  - Agilent Jet Stream Thermal Gradient Technology 36
  - Front-end ion optics 38

This chapter provides an overview of the Agilent 6200 Series TOF LC/MS and Agilent 6500 Series Q-TOF LC/MS systems and the system components and how they work together to help you get your job done.



## 1 Overview

How does the TOF and Q-TOF system help you do your job?

# How does the TOF and Q-TOF system help you do your job?

ESI – Electrospray Ionization  
APCI – Atmospheric Pressure  
Chemical Ionization  
APPI - Atmospheric Pressure  
Photo Ionization  
HPLC-Chip/MS – High Performance  
Liquid Chromatography on a Chip  
MALDI – Matrix-Assisted Laser  
Desorption Ionization  
MMI - Multimode Ionization

You can set up an Agilent 6200 Series Time-of-Flight LC/MS (TOF) system and the Agilent 6500 Series Quadrupole Time-of-Flight LC/MS (Q-TOF) system in several configurations:

- For normal flow LC/MS with a binary pump, quaternary pump, well-plate sampler (or autosampler or HTC/HTS autosampler) and ESI or Dual ESI with Agilent Jet Stream Thermal Gradient Technology - Agilent 6530 Quadrupole Time-of-Flight, Agilent 6540 Quadrupole Time-of-Flight, Agilent 6550 iFunnel Quadrupole Time-of-Flight, and Agilent 6230 Time-of-Flight.
- For normal flow LC/MS with a binary pump, quaternary pump, well-plate sampler (or autosampler or HTC/HTS autosampler) and ESI, Dual ESI, APCI, APPI, or MMI ion sources.
- For microflow LC/MS with a capillary pump, micro well-plate sampler and ESI, Dual ESI, APCI or MMI ion sources
- For nanoflow LC/MS with a nanopump, micro well-plate sampler and HPLC-Chip/MS interface (used in place of standard or dual nanospray source) to increase reliability and boost performance with narrow peak dispersion and lower dead volumes.
- Agilent 6200 Series TOF or 6500 Series Q-TOF LC/MS system with an AP-MALDI or PDF-MALDI source

Each Agilent system has advantages for high throughput sample screening with highly sensitive detection and accurate mass assignment. Each uses the same Agilent 6200 Series TOF or 6500 Series Q-TOF LC/MS software to enable these advantages.

The Agilent Accurate-Mass 6530 Q-TOF, the Agilent UHD Accurate-Mass 6540 Q-TOF LC/MS, and the Agilent 6550 iFunnel Q-TOF LC/MS systems are the only Q-TOF instruments that can use the Agilent Jet Stream Technology. The Agilent 6230 TOF LC/MS system is the only TOF that can use the Agilent Jet Stream Technology. This technology utilizes a

super-heated sheath gas to collimate the nebulizer spray which dramatically increases the number of ions that enter the mass spectrometer.

## Help for applications

You can use one or more of the Agilent 6200 Series TOF or 6500 Series Q-TOF LC/MS systems in the following application areas (for example):

- Combinatorial chemistry target compound analysis
- Natural products screening
- Compound profiling (e.g., bioavailability, pK)
- Protein/peptide identification and characterization
- Metabolomics
- Biomarker discovery
- Impurity profiling

Paired with Agilent's 1200 Series LCs, the 6500 Series Q-TOF LC/MS delivers fast, sensitive, reproducible analyses of small and large molecules.

- Reproducible mass accuracy
- Low picogram and femtomole limits of detection
- Fast MS/MS operation (for the Q-TOF)

## Help for data acquisition

Please refer to this guide, the *Agilent MassHunter Workstation Software - Data Acquisition Familiarization Guide*, the *Agilent MassHunter Workstation Software - Data Acquisition Quick Start Guide* or the online Help for the Data Acquisition program and the online Help or the Report Designer User Information DVD for the Report Designer Add-in. The Report Designer Add-in allows you to customize the templates that are used when you print a report.

To help you use the Agilent 6200 Series TOF and the 6500 Series Q-TOF LC/MS systems for these applications, the software lets you perform the following tasks in a single window:

### **Prepare the instrument**

*To learn how to get started with the Agilent 6200 Series TOF and 6500 Series Q-TOF, see the Quick Start Guide.*

*To learn more about how to use the Agilent 6200 Series TOF and 6500 Series Q-TOF with real samples and data, see the Familiarization Guide.*

*To learn how to perform individual tasks with the TOF and Q-TOF LC/MS, see the online Help. Press F1 to access the online Help.*

*To learn more about an Agilent 1100 or 1200 LC module or 1260 or 1290 Infinity LC module, see the Agilent 1100 LC, 1200 LC, 1260 Infinity LC or 1290 Infinity LC User Guide for the module.*

*To learn more about the 6200 Series TOF or the 6500 Series Q-TOF, see the Maintenance Guide for that instrument.*

*To learn how to install the system, see the Installation Guide.*

- Start and stop the instruments from the software.
- Download settings to the Agilent 1200, 1260 Infinity or 1290 Infinity liquid chromatograph and the TOF and Q-TOF mass spectrometer in real time to control the instrument.
- See if the 6200 Series TOF and 6500 Series Q-TOF parameters are within the limits to produce the specified mass accuracy and resolution with a Checktune, Quicktune or Standard tune report.
- Optimize TOF and Q-TOF parameters automatically or manually through Agilent tuning programs.
- Monitor the actual conditions of the instrument.
- View the Real-time Plot for chromatograms, spectra, and instrument parameters (both DAD, TOF and Q-TOF) and print a Real-time Plot report.
- View the centroided line spectrum of a peak or the mass range profile spectrum of a peak in real time.

### Set up data acquisition methods

- Enter and save parameter values for all LC modules and the Agilent 6200 Series TOF and 6500 Series Q-TOF to a data acquisition method.
- Enable reference mass correction and select reference standard masses to correct the mass assignments during a sample run.
- Select and label the total ion chromatograms or extracted ion chromatograms that you want to appear in the real-time plot.
- Set up time segments for each run where parameters change with the time segment or with the experiments within the time segment.
- Print an acquisition method report.

### Acquire data

- Enter sample information and pre- or post-analysis programs (scripts) and run single samples interactively
- Enter and automatically run both individual samples and sequences of samples in a *worklist*
- Set up pre- and post-analysis scripts to run between samples in a worklist.
- Set up and run a worklist.

A *worklist* is a list of a sequence of samples that you enter and run automatically with the Data Acquisition program.

## Help for data analysis

### Agilent MassHunter Workstation Software - Qualitative Analysis

Qualitative Analysis is the primary program you use to work with your TOF and Q-TOF data. You can use the Find Compounds capability to confirm the presence of known compounds with targeted MS/MS data, identify unknowns with auto MS/MS data and do molecular feature extraction with MS data. You can also search the data file for the presence of specified formulas.

Agilent also designed the Qualitative Analysis program to present large amounts of data for review in one central location. With the program you can perform these operations for any type of mass spectrometer data that you open:

- Extract and display chromatograms.
- View and extract peak spectra.
- Subtract background.
- Integrate chromatograms.

You can also set up methods to automatically do the tasks in the list, as well as others, when you open the data files. The software also provides preconfigured templates for basic reporting and enables the capability to create custom reports in Microsoft Excel.

Please refer to the *Agilent MassHunter Workstation Software - Qualitative Analysis Familiarization Guide* or the online Help for the Qualitative Analysis software and the online Help or Reporting Training DVD for the Report Designer Add-in. The Report Designer Add-in allows you to customize the templates that are used when you print a report.

You can also purchase the Agilent MassHunter BioConfirm Program which allows you to view the digest list for the protein sequences currently displayed. You can also compare a reference data file to other data files using the *Comparative Analysis* program which is available with BioConfirm. Please refer to the Agilent MassHunter BioConfirm Quick Start Guide or the Agilent MassHunter BioConfirm Familiarization Guide or the online Help for the Qualitative Analysis program for more information.

### **Agilent MassHunter Workstation Software - Quantitative Analysis**

Agilent also provides you with the opportunity to quantitate your data. Agilent has designed the quantitative analysis software to help quantitate very low amounts of material with the following unique features:

- Provides a curve-fit assistant to test all fits and statistics on curve quality

- Integrates with an automated, parameter-free integrator that uses a novel algorithm
- Presents a Batch-at-a-Glance results window to help you review and operate on an entire batch of data at once
- Automatically detects and identifies outliers

Please refer to the *Agilent MassHunter Workstation Quantitative Analysis Software Familiarization Guide* or the online Help for the Quantitative Analysis software. You can access the Familiarization Guide directly from the on

For the Report Designer Add-in, please refer to the online Help or Reporting Training DVD. The Report Designer Add-in allows you to customize the templates that are used when you print a report.

## 1 Overview

### How do different ion sources work?

## How do different ion sources work?

The Agilent 6200 Series TOF and 6500 Series Q-TOF LC/MS systems operate with the following interchangeable atmospheric pressure ionization (API) sources:

- “Electrospray ionization (ESI) and Dual ESI” on page 17
- “Dual Agilent Jet Stream Electrospray Ionization (Dual AJS ESI)” on page 21
- “Atmospheric pressure chemical ionization (APCI)” on page 22
- “Atmospheric pressure photoionization (APPI)” on page 24
- “Multimode ionization (MMI)” on page 25
- “HPLC-Chip” on page 27

#### NOTE

The sources that are used are the B-type sources.

---



## Electrospray ionization (ESI) and Dual ESI

*You control the spray chamber parameters (nebulizer pressure, drying gas flow and temperature, and capillary voltage) when you set up a method in the Method and Run Control view, described in Chapter 4.*

Electrospray ionization relies in part on chemistry to generate analyte ions in solution before the analyte reaches the mass spectrometer. As shown in Figure 1, the LC eluent is sprayed (nebulized) into a spray chamber at atmospheric pressure in the presence of a strong electrostatic field and heated drying gas. The electrostatic field occurs between the nebulizer, which is at ground in the Agilent design, and the capillary, which is at high voltage.

The spray occurs at right angles to the capillary. This design reduces background noise from droplets, increases sensitivity, and keeps the capillary cleaner for a longer period of time.

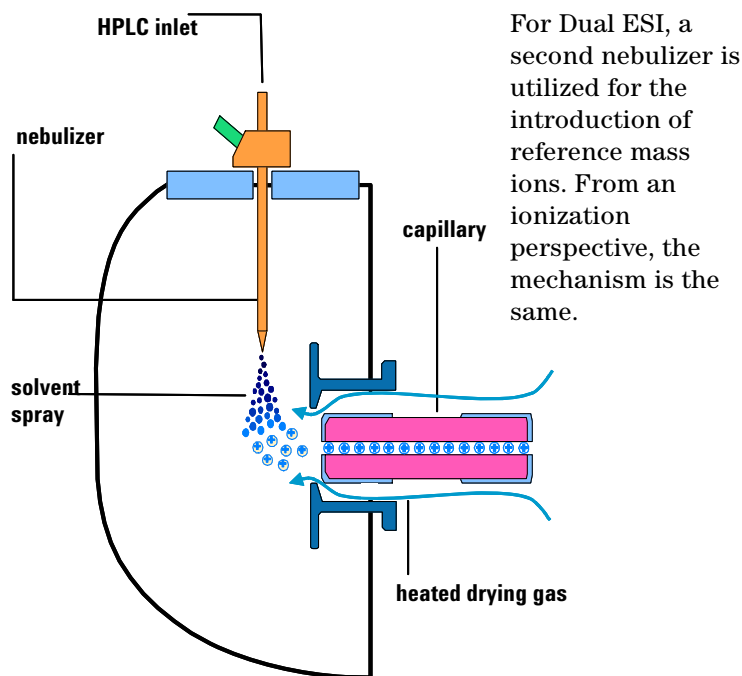

**Figure 1** Electrospray ion source

Electrospray ionization (ESI) consists of four steps:

## 1 Overview

### Electrospray ionization (ESI) and Dual ESI

- 1 Formation of ions
- 2 Nebulization
- 3 Desolvation
- 4 Ion evaporation

#### Formation of ions

Ion formation in API-electrospray occurs through more than one mechanism. If the chemistry of analyte, solvents, and buffers is correct, ions are generated in solution before nebulization. This results in high analyte ion concentration and good API-electrospray sensitivity.

Preformed ions are not always required for ESI. Some compounds that do not ionize in solution can still be analyzed. The process of nebulization, desolvation, and ion evaporation creates a strong electrical charge on the surface of the spray droplets. This can induce ionization in analyte molecules at the surface of the droplets.

#### Nebulization

Nebulization (aerosol generation) takes the sample solution through these steps:

- a Sample solution enters the spray chamber through a grounded needle called a nebulizer.
- b For high-flow electrospray, nebulizing gas enters the spray chamber concentrically through a tube that surrounds the needle.
- c The combination of strong shear forces generated by the nebulizing gas and the strong voltage (2–6 kV) in the spray chamber draws out the sample solution and breaks it into droplets.
- d As the droplets disperse, ions of one polarity preferentially migrate to the droplet surface due to electrostatic forces.
- e As a result, the sample is simultaneously charged and dispersed into a fine spray of charged droplets, hence the name *electrospray*.

Because the sample solution is not heated when the aerosol is created, ESI does not thermally decompose most analytes.

### Desolvation and ion evaporation

Before the ions can be mass analyzed, solvent must be removed to yield a bare ion.

A counter-current of neutral, heated drying gas, typically nitrogen, evaporates the solvent, decreasing the droplet diameter and forcing the predominantly like surface-charges closer together (see Figure 2).

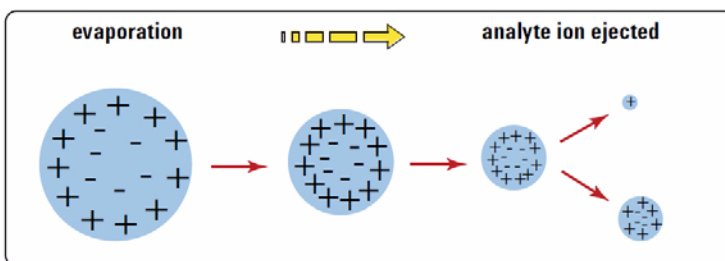

**Figure 2** Desorption of ions from solution

Coulomb repulsion – repulsion between charged species of the same sign

When the force of the Coulomb repulsion equals that of the surface tension of the droplet, the droplet explodes, producing smaller charged droplets that are subject to further evaporation. This process repeats itself, and droplets with a high density of surface-charges are formed. When charge density reaches approximately  $10^8$  V/cm<sup>3</sup>, ion evaporation occurs (direct ejection of bare ions from the droplet surface). These ions are attracted to and pass through a capillary sampling orifice into the ion optics and mass analyzer.

### The importance of solution chemistry

The choice of solvents and buffers is a key to successful ionization with electrospray. Solvents like methanol that have lower heat capacity, surface tension, and dielectric constant, promote nebulization and desolvation. For best results in electrospray mode:

## 1 Overview

### Electrospray ionization (ESI) and Dual ESI

- Adjust solvent pH according to the polarity of ions desired and the pH of the sample.
- To enhance ion desorption, use solvents that have low heats of vaporization and low surface tensions.
- Select solvents that do *not* neutralize ions through gas-phase reactions such as proton transfer or ion pair reactions.
- To reduce the buildup of salts in the ion source, select more volatile buffers.

#### Multiple charging

Electrospray is especially useful for analyzing large biomolecules such as proteins, peptides, and oligonucleotides, but can also analyze smaller molecules like drugs and environmental contaminants. Large molecules often acquire more than one charge. Because of this multiple charging, you can use electrospray to analyze molecules as large as 150,000 u even though the mass range (or more accurately mass-to-charge range) for a typical quadrupole LC/MS instrument is around 3000  $m/z$ . For example:

$$100,000 \text{ u} / 10 \text{ z} = 1,000 \text{ m/z}$$

*The optional Agilent MassHunter BioConfirm Software performs the calculations to accomplish deconvolution.*

When a large molecule acquires many charges, a mathematical process called deconvolution is used to determine the actual molecular weight of the analyte.

## Dual Agilent Jet Stream Electrospray Ionization (Dual AJS ESI)

With the Dual AJS ESI source, the nebulizing gas for the reference spray can be switched for high flow or low flow applications. The second sprayer improves the reference mass stability over a wide range of LC conditions. Low flow applications are typically less than 200  $\mu\text{L}/\text{minute}$ . If the flow is approximately 200  $\mu\text{L}/\text{minute}$ , either low or high flow may be appropriate.



You connect the tubing here for low flow applications.

**Figure 3** Dual AJS ESI source plumbed for high flow application

Both the Dual AJS ESI and the Dual ESI source support two nebulizers for different applications: the standard nebulizer (G1958-60098) and the capillary (or microflow) LC/MS nebulizer (G1946-60260). The main differences are:

- The machined tip of the capillary LC/MS nebulizer has a smaller exit orifice and internal taper.
- The internal diameter (ID) of the internal needle for the capillary LC/MS nebulizer is 50  $\mu\text{M}$  versus 120  $\mu\text{M}$  for the “standard” nebulizer needle.

The recommended flow range (1 to 50  $\mu\text{L}/\text{minute}$ ) really is capillary flow, whereas flows from 50 to 250  $\mu\text{L}/\text{minute}$  are typically described as microflow.

## Atmospheric pressure chemical ionization (APCI)

APCI is a gas-phase chemical ionization process. The APCI technique passes LC eluent through a nebulizing needle, which creates a fine spray. The spray is passed through a heated ceramic tube, where the droplets are fully vaporized (Figure 4).

The resulting gas/vapor mixture is then passed over a corona discharge needle, where the solvent vapor is ionized to create reagent gas ions. These ions in turn ionize the sample molecules via a chemical ionization process. The sample ions are then introduced into the capillary.

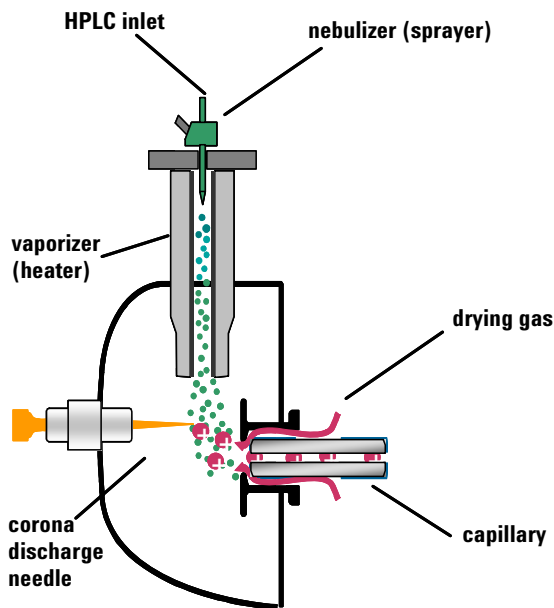

**Figure 4** Atmospheric pressure chemical ionization (APCI) source

APCI requires that the analyte be in the gas phase for ionization to occur. To vaporize the solvent and analyte, the APCI source is typically operated at vaporizer temperatures of 400 to 500°C.

## Atmospheric pressure chemical ionization (APCI)

APCI is applicable across a wide range of molecular polarities. It rarely results in multiple charging, so it is typically used for molecules less than 1,500 u. Because of this molecular weight limitation and use of high-temperature vaporization, APCI is less well-suited than electrospray for analysis of large biomolecules that may be thermally unstable. APCI is well suited for ionization of the less polar compounds that are typically analyzed by normal-phase chromatography.

## Atmospheric pressure photoionization (APPI)

With the APPI technique, LC eluent passes through a nebulizing needle to create a fine spray. This spray is passed through a heated ceramic tube, where the droplets are fully vaporized. The resulting gas/vapor mixture passes through the photon beam of a krypton lamp to ionize the sample molecules (Figure 5). The sample ions are then introduced into the capillary.

APPI and APCI are similar, with APPI substituting a lamp for the corona needle for ionization. APPI often also uses an additional solvent or mobile phase modifier, called a “dopant”, to assist with the photoionization process.

APPI is applicable to many of the same compounds that are typically analyzed by APCI. APPI has proven particularly valuable for analysis of nonpolar compounds.

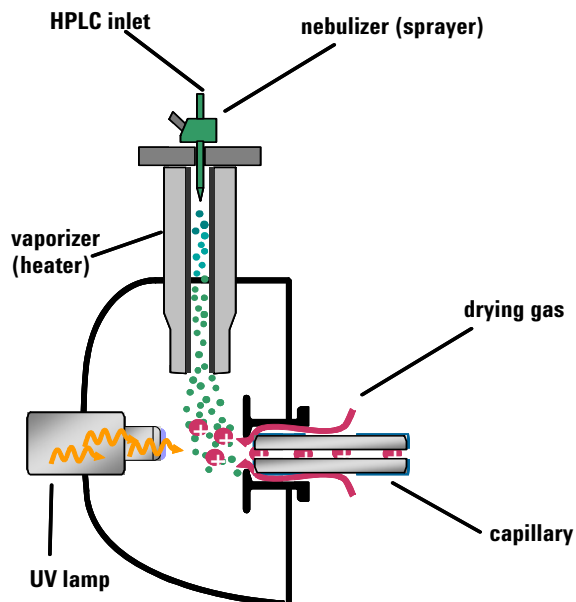
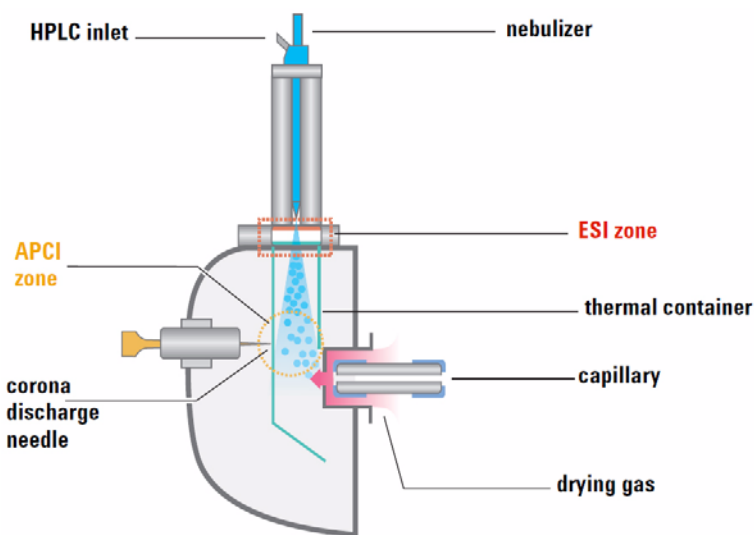

**Figure 5** Atmospheric pressure photoionization (APPI) source



## Multimode ionization (MMI)

The multimode source is an ion source that can operate in three different modes: APCI, ESI or simultaneous APCI/ESI. The multimode source incorporates two electrically separated, optimized zones: one for ESI and one for APCI. During simultaneous APCI/ESI, ions from both ionization modes enter the capillary and are analyzed simultaneously by the mass spectrometer.



**Figure 6** Multimode source

ESI and APCI are essentially incompatible processes because each needs its own conditions for aerosol drying and electrical fields. However, it is possible to form ions simultaneously from ESI and APCI if the two ionization regions are separated in space.

Multimode ionization (MMI) is useful for screening of unknowns, or whenever samples contain a mixture of compounds where some respond by ESI and some respond by APCI. In these cases, the multimode source obviates the need to run the samples twice to accomplish a complete analysis.

## 1 Overview

### Multimode ionization (MMI)

Unlike the APCI and APPI sources where the temperature of the vaporizer is monitored, in the multimode source the actual vapor temperature is monitored. As a result, the vaporizer is typically set to between 200 and 250°C.

## HPLC-Chip

Traditional nanospray mass spectrometry has proven its potential as a cost-effective, sensitive and reproducible technique for the identification of peptides at femtomole to attomole levels. However, connecting nano capillaries, columns and valves frequently is a tedious procedure and requires user skills and routine. When handled incorrectly, nano flow connections are prone to leakage which are difficult to detect and result in poor system performance and extended downtime of the complete system. Quartz nanospray needles are prone to blockages and require frequent replacement.

With the invention of HPLC-Chip technology, Agilent is significantly reducing the need for user interaction and making nanospray a rugged state-of-the-art technology.

The cornerstone of chip technology is the HPLC-Chip, a 3-dimensional structure made of sandwiched polyimide films. Grooves of specific dimensions are laser-ablated into a layer of polyimide film. The lamination of a top and bottom layer then forms channels of trapezoidal or triangular shape inside the chip which can either be used as capillaries or, if filled with packing material, as nanocolumns. One end of the chip tapers off into a polyimide nanospray emitter.

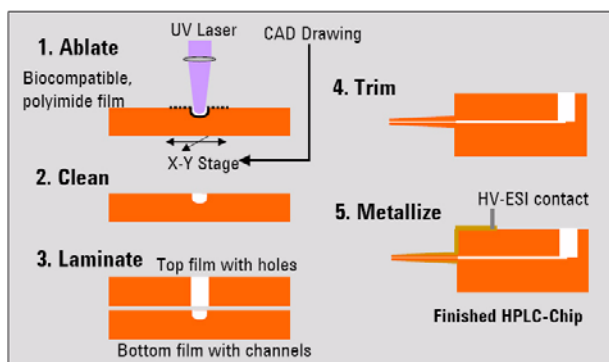

**Figure 7** HPLC-Chip making process

## 1 Overview

### How does the Agilent TOF and Q-TOF mass spectrometer work?

# How does the Agilent TOF and Q-TOF mass spectrometer work?

**6200 Series TOF** The Agilent TOF is an orthogonal acceleration time-of-flight mass spectrometer (oa-TOF). The acceleration pulse applied to send the ions down the flight tube is orthogonal to the direction that ions are entering the mass analyzer. This geometry minimizes the effect of the entrance velocity on the flight time, leading to higher resolution.

**6500 Series Q-TOF** The Agilent 6500 Series Q-TOF LC/MS is a liquid chromatograph Q-TOF mass spectrometer that performs MS/MS using a quadrupole, a hexapole (collision cell) and a time-of-flight unit to produce spectra. The quadrupole selects precursor ions that are fragmented in the collision cell into product ions, which are then impelled to the detector, at an angle perpendicular to the original path.

The Agilent 6500 Series Q-TOF LC/MS supports several atmospheric pressure ionization (API) sources. A common atmospheric sampling interface introduces ions from these various sources into the mass spectrometer vacuum system.

**Figure 8** shows the complete Agilent 6520 Q-TOF LC/MS schematic, including ion source, ion transfer optics, beam shaping optics, ion pulser, flight tube, and detector.

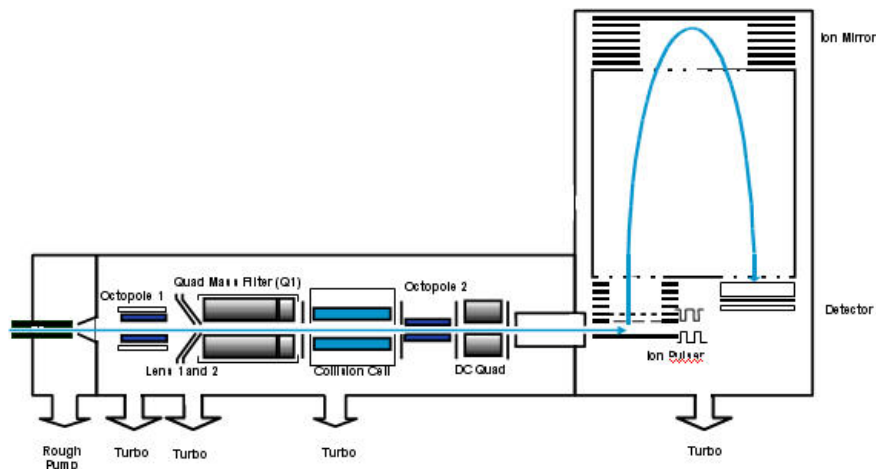

**Figure 8** Schematic of Agilent 6520 Q-TOF LC/MS

How does the Agilent TOF and Q-TOF mass spectrometer work?

Figure 9 shows the complete Agilent 6530 Q-TOF schematic, with major improvements identified.

These improvements are described below (“Innovative Enhancements in the 6530 Q-TOF” on page 35).

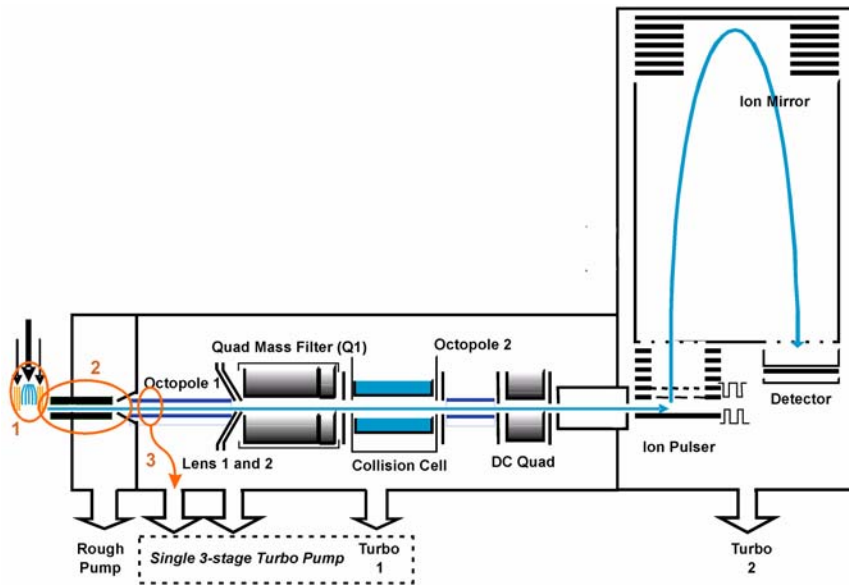

Figure 9 Schematic of Agilent 6530 Q-TOF LC/MS with major improvements circled

## 1 Overview

How does the Agilent TOF and Q-TOF mass spectrometer work?

Figure 10 shows the complete Agilent 6538/6540 Q-TOF schematic, with major improvements identified.

These improvements are described below (“Innovative Enhancements in the 6540 and 6538 Q-TOF” on page 33).

*The Agilent 6540 Q-TOF supports the Agilent Jet Stream Technology. The Agilent 6538 does not.*

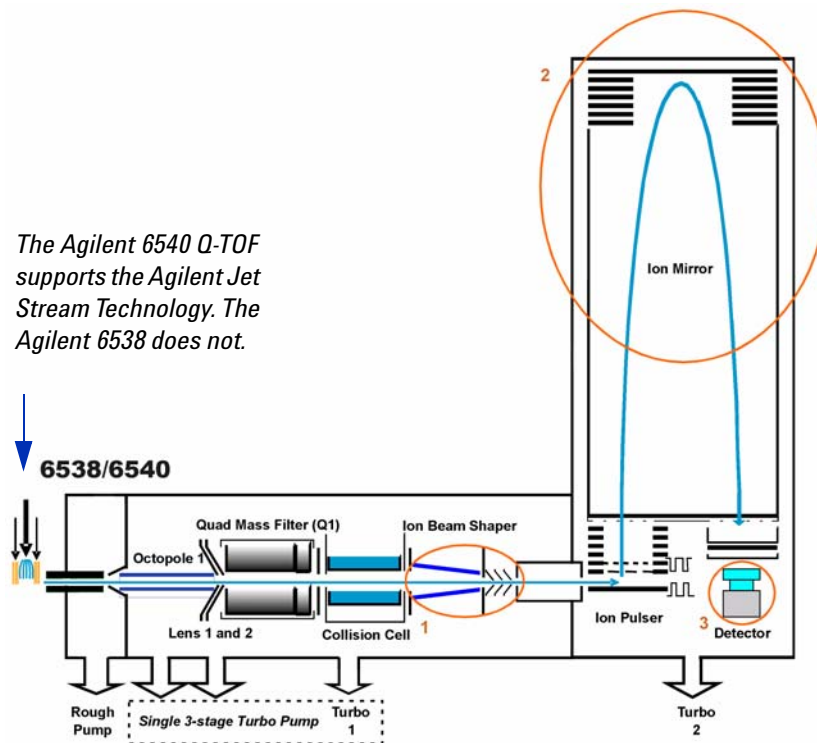
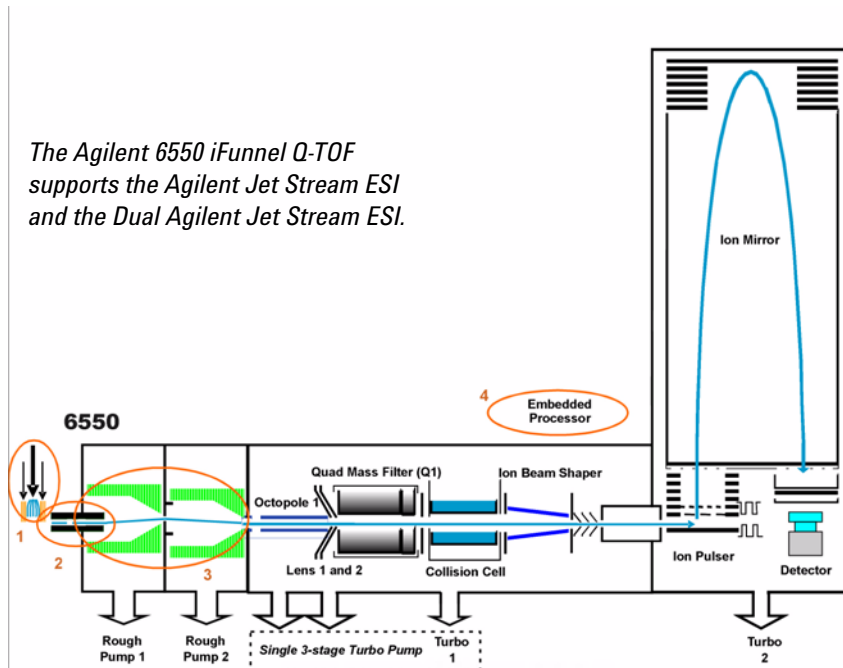

Figure 10 Schematic of Agilent 6540 UHD Accurate-Mass Q-TOF LC/MS with major improvements circled

This figure shows the complete Agilent 6550 iFunnel Q-TOF schematic, with major improvements identified.

These improvements are described below (“[Innovative Enhancements in the Agilent 6550 iFunnel Q-TOF](#)”).



**Figure 11** Schematic of Agilent 6550 iFunnel Q-TOF LC/MS with major improvements circled

## Innovative Enhancements in the Agilent 6550 iFunnel Q-TOF

### Dual Agilent Jet Stream Electrospray

The Dual Agilent Jet Stream Electrospray source allows you to modify it for high flow and low flow applications. See “[Dual Agilent Jet Stream Electrospray Ionization \(Dual AJS ESI\)](#)” on page 21 for more information.

### iFunnel Technology

The iFunnel Technology encompasses two enhancements to the Agilent 6550 iFunnel Q-TOF: the Agilent Jet Stream technology, a hexabore capillary and the Dual Ion Funnel technology.

## 1 Overview

### Innovative Enhancements in the Agilent 6550 iFunnel Q-TOF



**Figure 12** The iFunnel Technology

Ions are generated using an electrospray ion source where the analyte is simultaneously ionized and desolvated from the liquid matrix. The iFunnel includes the application of Agilent Jet Stream Technology (first introduced with the 6530) which improves sensitivity via thermal gradient focusing and enhanced desolvation.

The next innovative enhancement is the use of a short hexabore capillary. It has 6 capillary inlets and samples up to 10X more ion rich gas from the source. It captures the majority of the gas from the source region. See [Figure 13](#). The hexabore capillary transmits a high gas/ion volume into the ion optic system.

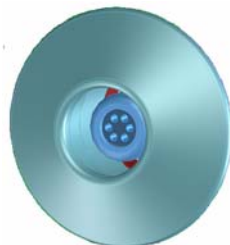
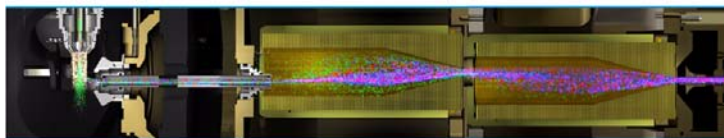

**Figure 13** Hexabore capillary



The Dual Ion Funnel (DIF) technology is the next enhancement. The DIF technology removes the gas and neutral noise but captures the ions. It also extends the turbo pump's lifetime. The Dual Ion Funnel technology can transmit ions efficiently at as high a pressure as possible. The first ion funnel has a pressure between 7 and 14 torr. The second ion funnel is a low pressure ion funnel (1 to 3 torr). The ion funnel works by having the RF voltage focus the ions to the center and having the DC voltage accelerate the ions to the exit. See Figure 14.

<b>Agilent Jet Stream Technology</b>	<b>Hexabore Capillary</b>	<b>Dual Stage Ion Funnel</b>
--	-------------------------------	----------------------------------



**Figure 14** The Dual Ion Funnel technology

### Embedded processor

## Innovative Enhancements in the 6540 and 6538 Q-TOF

### Ion Beam Compression Technology

The first improvement is the Ion Beam Compression Technology (IBC) which cools and focuses the ion beam. This technology simultaneously maximizes ion transmission and reduces beam divergence. Active Ion Beam Compression is achieved with Agilent's Axial Ion Acceleration Technology applied to a tapered ion guide design.

Ion beam compression provides up to a 10-fold compression and cooling which helps in creating a much denser and thinner ion beam that passes through a narrower slit leading into the slicer

## 1 Overview

### Innovative Enhancements in the 6540 and 6538 Q-TOF

and pulser region. The narrowed, cooled and condensed beam is a key factor in enabling the gain in mass resolution to 40,000 while maintaining excellent sensitivity.

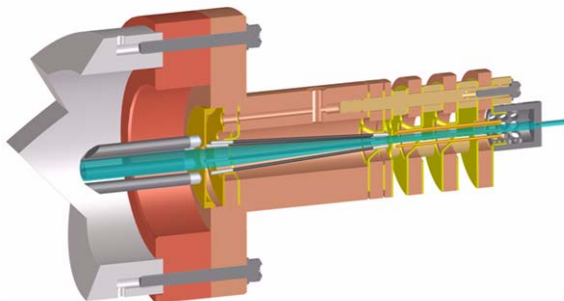

**Figure 15** Ion Beam Compression Technology

#### **Extended Flight Tube with Enhanced Mirror Technology (EMT)**

The second improvement is that the flight tube for the 6538/6540 Q-TOF is now five feet long.

The 1 ppm/C Expansion Coefficient for the Inner Flight Tube virtually eliminates calibration drift due to flight tube elongation. The second order temporal focusing ion mirror uses a high transmission Harp Grid for maximum sensitivity.

#### **New Fast Bipolar Detector**

The third innovative enhancement is the new Fast Bipolar detector. The scintillator is ultra fast and highly efficient. Also, the new ultra fast response PMT design continues the tradition of high dynamic range and detector lifetime.



**Figure 16** Fast Bipolar Detector

## Innovative Enhancements in the 6530 Q-TOF

Ions are generated using an electrospray ion source where the analyte is simultaneously ionized and desolvated from the liquid matrix. The first of three (3) innovative Agilent enhancements is found in the application of Agilent Jet Stream Technology (denoted as 1 in [Figure 9](#)) which improves sensitivity via thermal gradient focusing and enhanced desolvation. This technology is described in detail below (“[Agilent Jet Stream Thermal Gradient Technology](#)” on page 36).

The desolvated ions then enter the mass spectrometer via an innovative resistive and highly inert capillary transfer tube (denoted as 2 in [Figure 9](#)) that improves ion transmission and allows virtually instantaneous polarity switching.

Further increase in ion transmission is obtained by improvement of the pumping speed in vacuum stage 2, resulting in better ion capture by the first octopole (denoted as 3 in [Figure 9](#)). The ions next pass through the optics and into the quadrupole analyzer. The quadrupole analyzer consists of four parallel hyperbolic rods through which selected ions based on their mass to charge ratio are filtered.

## 1 Overview

### Agilent Jet Stream Thermal Gradient Technology

The ions passing through the quadrupole analyzer are then directed through the collision cell where they are fragmented. The collision cell is actually a hexapole filled with nitrogen, the same gas that is used as the drying gas. The collision cell design has axial acceleration for high speed MS/MS analysis. Fragment ions formed in the collision cell are then sent to the TOF to enable a user to isolate and examine product ions with respect to precursor ions.

## Agilent Jet Stream Thermal Gradient Technology

This technology is supported on the Agilent 6530 Quadrupole Time-of-Flight mass spectrometer, the Agilent 6540 UHD Accurate-Mass Quadrupole Time-of-Flight mass spectrometer, the Agilent 6550 iFunnel Quadrupole Time-of-Flight mass spectrometer and the Agilent 6230 Accurate-Mass Time-of-Flight mass spectrometer.

Agilent Jet Stream Technology enhances analyte desolvation by collimating the nebulizer spray and creating a dramatically “brighter signal.” The addition of a collinear, concentric, super-heated nitrogen sheath gas ([Figure 17](#)) to the inlet assembly significantly improves ion drying from the electrospray plume and leads to increased mass spectrometer signal to noise. The Agilent 6530 Q-TOF gets attomole-to-low-femtomole sensitivity for superior trace level analyses.

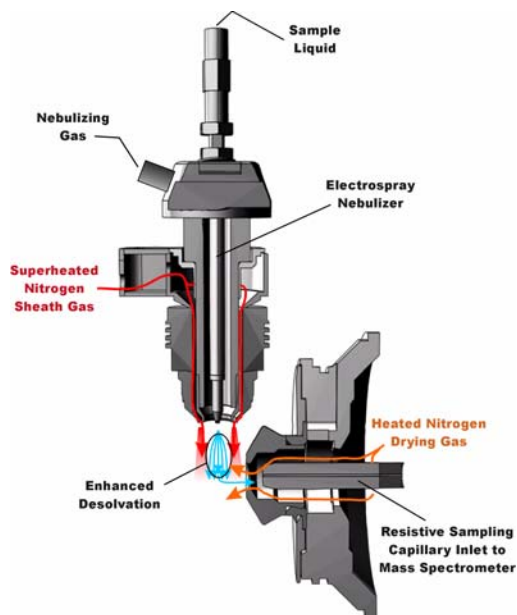

**Figure 17** Agilent Jet Stream Electro Spray Ion Source

Agilent Jet Stream thermal gradient focusing consists of a superheated nitrogen sheath gas that is introduced collinear with and concentric to the pneumatically assisted electrospray. Thermal energy from the superheated nitrogen sheath gas is focused to the nebulizer spray producing the most efficient desolvation and ion generation possible. The enhanced desolvation results in more ions entering the sampling capillary as shown in [Figure 17](#) and concomitant improved signal to noise. Parameters for the Agilent Jet Stream Technology are the superheated nitrogen sheath gas temperature and flow rate, and the nozzle voltage.

The capillary is a resistive capillary that improves ion transmission and allows virtually instantaneous polarity switching.

## Front-end ion optics

For information on the various ion sources, see “[How do different ion sources work?](#)” on page 16

After the API source forms ions, the Agilent 6200 Series TOF or 6500 Series Q-TOF LC/MS system performs the following operations, organized according to the stages of the ion path and the vacuum stages of the TOF or Q-TOF. See [Figure 8](#) on page 28 for details.

### **Ion enrichment (Vacuum stage 1)**

Ions produced in an API source are electrostatically drawn through a drying gas and then pneumatically conducted through a heated sampling capillary into the first stage of the vacuum system. The majority of drying gas and solvent vapor are deflected by the skimmer and exhausted by a rough pump. The ions that pass through the skimmer pass into the second stage of the vacuum system.

### **Ion transport 1 (Vacuum stage 2 and vacuum stage 3)**

*An octopole ion guide is a set of small parallel metal rods with a common open axis through which the ions can pass.*

In this stage the ions are immediately focused by an *octopole ion guide*. Radio frequency voltage applied to the parallel octopole rods repel ions above a particular mass range toward the center of the rod set. The ions pass through the octopole ion guide because of the momentum obtained from being drawn from atmospheric pressure through the sampling capillary.

In a Q-TOF and in the Agilent G6224 and G6230 TOF, the octopole spans both the 2nd and the 3rd vacuum stages. Ions exit the octopole and pass through two focussing lenses and an RF lens.

In an Agilent 6220 TOF, the ions exit the first ion guide and pass into the third stage of the vacuum system. In the third stage of the vacuum, the ions are passed onto a second octopole assembly (octopole 2) which then sends the ion on to the beam shaping assembly.

### Ion transport 2 (Vacuum stage 4 for 6220 TOF only)

In this fourth vacuum pumping stage, the pressure is now low enough that there are few collisions of the ions with gas molecules.

#### NOTE

The following sections are only part of the Q-TOF LC/MS instrument. The next section in the TOF instrument is the [Beam shaping \(Vacuum stage 4 for both 6220 TOF and Q-TOF\)](#) on page 40.

### Ion selection (Vacuum stage 4 for Q-TOF only)

<b>Lens 2 RF</b>	The phase of lens 2 RF is matched to that of the subsequent quadrupole resulting in a significantly increased sensitivity.
<b>Quad mass filters</b>	The quadrupoles consist of hyperbolic rods that optimize ion transmission and spectral resolution. There tends to be more ion loss with circular rods.
<b>Pre-filter</b>	The end section of the quadrupole also consists of short hyperbolic rods, but their RF voltages are only high enough to guide ions into the collision cell.

### Ion fragmentation 2 (Vacuum stage 4 for Q-TOF only)

Ions selected by the quadrupole are then passed to the collision cell where they are fragmented.

The axial acceleration collision cell is a high pressure hexapole assembly with its axial acceleration adjusted to maximize sensitivity while eliminating crosstalk.

*Crosstalk* occurs when product ions from a previously selected precursor appear in a product ion spectrum of a subsequently selected precursor because of slow clearance from the collision cell. This creates a composite product ion spectrum which can be difficult to interpret.

The components that contribute to this higher sensitivity and faster response are

- Small diameter hexapole collision cell
- High frequency hexapole collision cell

- Linear axial acceleration
- High pressure collision cell
- High speed digital electronics

The collision cell contains nitrogen, the same gas that is used in the ion source. The small diameter of the hexapole assembly assists in capturing fragmented ions.

**Why a hexapole?** The geometry of a hexapole provides advantages in two domains: ion focusing and ion transmission.

- The first advantage is in ion focusing where a quadrupole is better than a hexapole, which is better than an octopole, that is, quadrupole > hexapole > octopole.
- The second advantage involves ion transmission across a wide mass range, or  $m/z$  bandwidth. In this case, the octopole is better than the hexapole, which is better than the quadrupole.

The hexapole is chosen because, overall, it is the best for both ion focusing and ion transmission.

**Collision cell design** The collision cell hexapole consists of six resistively coated rods used to generate a potential difference across the length of the collision cell.

A potential difference is always present. This ensures that the precursor ions coming from the quadrupole or fragment ions generated in the collision cell are transmitted and not allowed to drift around at random.

Sweeping out the ions in this manner avoids the issue of crosstalk where residual product ions from a previous experiment can interfere with the product ion spectrum of a subsequent experiment. A collision energy voltage is applied over the accelerating linear voltage to generate fragments or product ions.

#### **Beam shaping (Vacuum stage 4 for both 6220 TOF and Q-TOF)**

In the Agilent 6538 and 6540 UDH Accurate-Mass Q-TOF, ions enter the ion beam compression technology. Ion beam compression provides up to a 10-fold compression and cooling



which helps in creating a much denser and thinner ion beam that passes through a narrower slit leading into the slicer and pulser region.

In the TOF, ions enter a second octopole ion guide of similar design to the first octopole but with a lower direct current potential. This second octopole ion guide accelerates the ions and prepares them for beam shaping. For TOF, the fourth vacuum stage contains Octopole 2 and the beginning of the slicer assembly.

To facilitate beam shaping, lenses focus the ions so that as they pass through the 4th vacuum stage they will enter the time-of-flight analyzer as a parallel beam. The more parallel the ion beam, the higher the resolution in the resulting mass spectrum. After the ions have been shaped into a parallel beam, they pass through a slit opening into the fifth and last vacuum stage where the time-of-flight analysis takes place.

#### **Flight tube/Mass Analyzer (Vacuum stage 4 for 6224/6230 TOF) (Vacuum stage 5 for 6220 TOF and 6500 Series Q-TOF)**

- Ion pulser** The nearly parallel beam of ions passes into the time-of-flight ion pulser. The ion pulser is a stack of plates, each one (except the back plate) with a center hole. The ions pass into this stack from the side just between the back plate and the first plate with its center hole. To start the flight of the ions to the detector, a high voltage (HV) pulse is applied to the back plate. The applied pulse accelerates the ions through the stack of pulser plates, acting as a rapid-fire ion gun.
- Flight tube** The ions leave the ion pulser and travel through the flight tube, which is about one meter in length (see [Figure 8](#)). At the opposite end of the flight tube is an ion “mirror”, which reflects the ions that arrive near the end of the flight tube towards the ion pulser. Because the ions entered the ion pulser with a certain amount of forward momentum orthogonal to the flight direction in the flight tube, they never return to the ion pulser, but move to where the ion detector is mounted.

The ion mirror increases the resolving power of the instrument by effectively doubling the flight distance (from one meter to two meters) in the same space, and by performing a refocusing

operation so that ions having different initial velocities still arrive simultaneously at the detector.

Because the calculation for the mass of each ion depends on its flight time in the flight tube, the background gas pressure must be very low. Any collision of an ion with residual gas slows the ion on its path to the detector and affects the accuracy of the mass calculation.

**Ion detection** Figure 18 shows a schematic of the Agilent 6500 Series Q-TOF LC/MS detector.

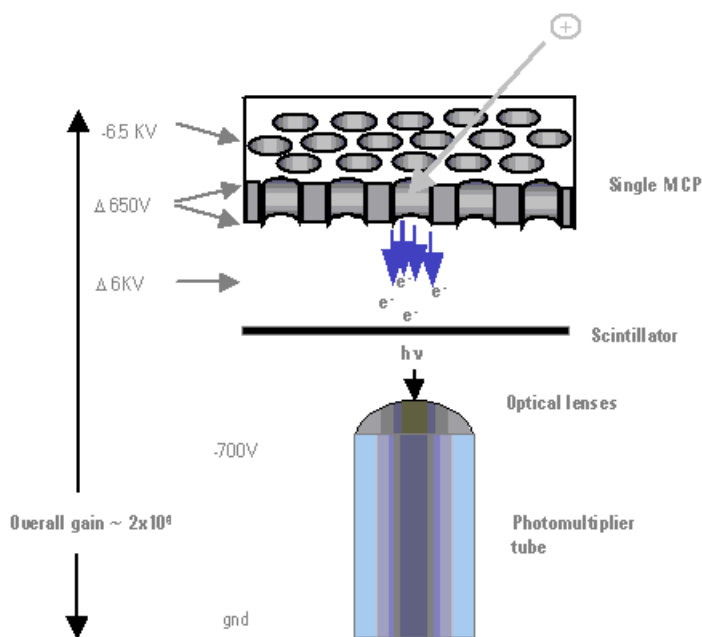

**Figure 18** Agilent 6200 Series TOF or 6500 Series Q-TOF detector, with potentials shown for positive operation

At the surface of the ion detector is a microchannel plate (MCP), a very thin plate containing a set of microscopic tubes that pass from the front surface to the rear of the plate. When an ion hits the front surface of the MCP, an electron escapes and begins the process of electrical signal amplification. As freed electrons collide with the walls of the microscopic tubes, an

ever-increasing cascade of electrons travels to the rear of the plate. Roughly 10 times more electrons exit the MCP than incoming ions contact the surface.

These electrons are then focused onto a scintillator, which, when struck by electrons, produces a flash of light. The light from the scintillator is focused through two small lenses onto a photomultiplier tube (PMT), which produces the electrical signal read by the data system. The reason for producing an optical signal from the MCP electrons is because the output of the MCP is at roughly -6000 volts. The light produced by the scintillator passes to the PMT, which has a signal output at ground potential.

**1 Overview**  
Front-end ion optics

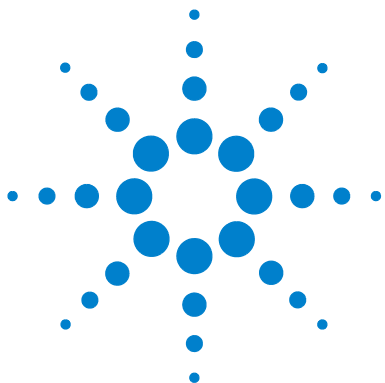

## 2 Instrument Preparation

LC preparation	46
LC module setup	46
Column equilibration and conditioning	48
TOF and Q-TOF preparation – calibration and tuning	51
TOF mass calibration	51
Tuning choices	53
Tune reports	59
Storage and retrieval of tune results and Instrument Mode	60
Tune Set Point Modifications for Medium and Large Proteins	62
Real-time displays	63
Instrument Status Window	63
Real-time parameter values (Actuals)	64
Real-time Chromatogram Plot and Spectral Plot windows	66
System logbook	68

Learn about the concepts that can help you prepare the instrument for use.

This chapter assumes that the hardware and software are installed, the instrument is configured and the performance verified. If this has not been completed, see the *Agilent 6200 Series Time-of-Flight LC/MS System Installation Guide* or the *Agilent 6500 Series Quadrupole Time-of-Flight LC/MS System Installation Guide*.



## LC preparation

To install, configure and start the LC modules, see the *Installation Guide*.

See the *Quick Start Guide* and *online Help* for instructions on how to prepare the LC for a sample run.

To prepare the LC for sample runs, you usually do three tasks:

- Set up the LC modules for operation
- Equilibrate or condition the column
- Monitor the plot baseline to assure pump and column stability (See “[Real-time displays](#)” on page 63.)

You can also view the system logbook for explanations of errors. (See “[System logbook](#)” on page 68.)

## LC module setup

You set up the LC modules in the Instrument Status window through the shortcut menus. The Instrument Status window is also called the Dashboard.

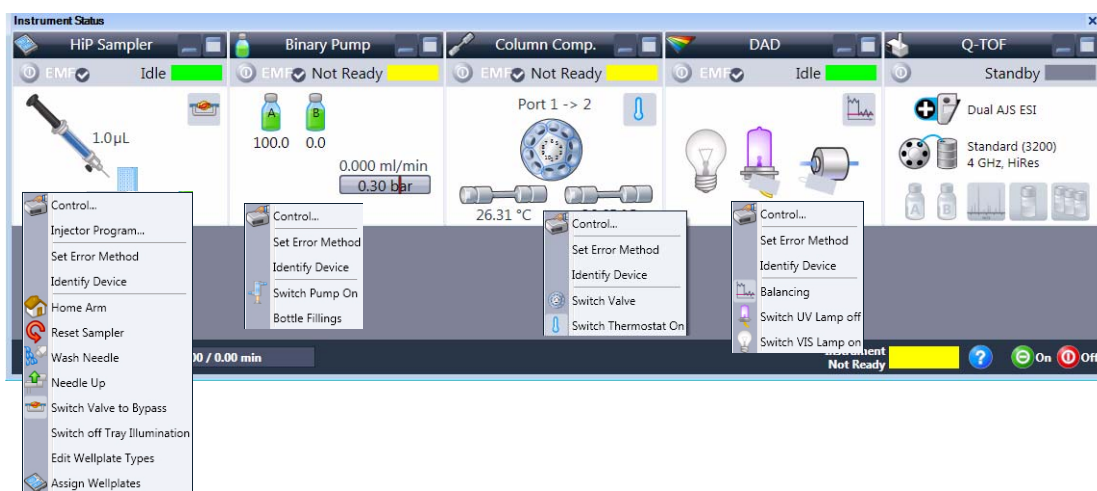

Figure 19 Instrument Status window (or Dashboard) with shortcut menus for LC modules

Table 1 shows you the tasks that you may perform to set up the LC modules and the menu items where you can do the tasks. You can do most of these tasks using the shortcut menu.

**Table 1** Tasks to set up the LC modules

If you have this module:	And you want to:	How:
Autosampler	Change volumes for the installed syringe	Done in the Device Configuration user interface
Well-Plate Sampler (WPS) or $\mu$ WPS or h-ALS or h-ALS-SL or h-ALS-SL+	Change volumes for the installed syringe	Done in the Device Configuration user interface
	Select tray type and its position	Right-click the device panel and click <b>Assign Wellplates, Edit Wellplate Types</b>
	Reset injector, Move Home, Needle Up or Down, set the valve mainpass or the bypass	Right-click the device panel and click <b>Reset Sampler, Home Arm, Needle Up/Down, Switch Valve to Bypass/Mainpass, Switch Thermostat On, Wash Needle</b>
HTC/HTS	Update the plate assignments on the computer	Right-click the device panel and click <b>Update Plate Assignment</b>
	Reset the injector	Right-click the device panel and click <b>Reset injector</b>
Binary, isocratic, and quaternary pumps	Turn the pump on, off or place in Standby	Right-click the device panel and click <b>Switch Pump On/Off</b>
	Set the date and time for automatic pump turnon	Right-click the device panel and click <b>Control</b>
	Set up to monitor solvent levels	Right-click the device panel and click <b>Bottle Fillings</b>
CapPump	Do same tasks as binary pump	Same menu items as binary pump
	Purge the pump	Right-click the device panel and click <b>Purge On/Off</b>
	Set mixer and filter volumes	Right-click the device panel and click <b>Configuration</b>
	Enable a fast change in solvent composition	Right-click the device panel and click <b>Start Fast Composition Change</b>

## 2 Instrument Preparation

### Column equilibration and conditioning

**Table 1** Tasks to set up the LC modules (continued)

<b>If you have this module:</b>	<b>And you want to:</b>	<b>How:</b>
	Do a flow sensor calibration	Right-click the device panel and click <b>Calibration</b>
Nanopump	Do the same tasks as CapPump	Same menu items as CapPump except for Accuracy Calibration (flow sensor)
Thermostat. Column Compartment (TCC)	Turn the right or left controller on or off	Right-click the device panel and click <b>Configuration</b>
	Set the maximum controller temperatures	Right-click the device panel and click <b>Set Temperature</b>
	Enter information for the instrument columns	Tools > Analytical Column Setup
Diode Array Det. (DAD)	Turn UV or Visible lamp on	Right-click the device panel and click <b>UV Lamp On</b> ; Vis Lamp On
	Set the date or time for automatic DAD turnon	Right-click the device panel and click <b>Control</b>
	Calibrate the DAD wavelength	Right-click the device panel and click <b>Calibration</b>
	Bring the baseline of the plot to zero	Right-click the device panel and click <b>Balance</b>
	Show an intensity plot for the detector	Right-click the device panel and click <b>Intensity plot</b>

## Column equilibration and conditioning

You can set up to equilibrate or condition a column in different ways with the Data Acquisition program.

**Equilibration** Column equilibration eliminates any previously separated compounds or impurities from the column after runs with solvent of a single composition. To equilibrate a column before a sample run, you pass the solvent that you intend to use for the run through the column for a period of time.



**Conditioning** Column conditioning returns column characteristics to their initial state after a gradient run. To condition a column before a sample run, you pass the solvent of initial composition through the column for a period of time.

### Equilibration

You can equilibrate a column in one of three ways:

- Interactively

You change the loaded method set points to the solvent composition for the run, no volume for the injection, higher than normal flow rates and no data storage. You can then immediately apply these set points to the instrument and interactively stop the run when the column is ready.

## 2 Instrument Preparation

### Column equilibration and conditioning

*For more information on worklists, see Chapter 4, "Data Acquisition".*

- With a method in an interactive run

You can save the method with the set points mentioned in the above paragraph, and then do a run. The run uses the method stop time. You can also use a post run time within a sample method to equilibrate the column.

- With a parameter in a worklist

You can set up a blank run in a worklist to use as your equilibration run. Or you can set up an equilibration time for any sample run, where the system waits the specified time before injecting the sample. For both cases, the data is stored.

### Conditioning

You can condition a column in one of three ways:

- With one of the first two procedures described in the Equilibration paragraphs.

You enter pump conditions to bring the column to its initial condition. You can also condition the column by setting a post-run time in the method.

- With a script in a worklist

The LC conditioning script, SCP\_LCCondition, is part of the Data Acquisition software. When you enter the script into the worklist, you specify the method that you will use for the run. If a TOF or Q-TOF is connected to the LC, you can also enter a parameter that diverts the LC eluent to waste. With this script, there is no injection and no data storage.

## TOF and Q-TOF preparation – calibration and tuning

See the *Installation Guide* for instructions on how to install and start the TOF or Q-TOF and perform an initial autotune.

To learn how to tune and calibrate the TOF or Q-TOF, see the *Quick Start Guide* and *online Help*.

See “*Tuning choices*” on page 53 to learn more about Agilent tuning tools.

After you start the instrument, you calibrate and tune the TOF and Q-TOF. This section presents the background information to help you understand calibration and tuning as they are implemented in the Agilent TOF and Q-TOF LC/MS system.

The following distinctions show how tuning, optimization and calibration are related in the Agilent MassHunter Workstation Software.

### Tuning

Tuning is the process of adjusting both the quadrupole (for the Q-TOF) and TOF parameters to achieve the following goals:

- Maximize signal intensity and maintain acceptable resolution, or
- Maximize resolution and maintain acceptable signal intensity

The Agilent MassHunter Workstation software and its documentation and online Help use the words “tuning” and “optimization” interchangeably.

Agilent Autotune for the TOF and Q-TOF include Initial Autotune, Checktune, Standard Tune, and Set Detector Gain for TOF parameters. The tools for optimizing the TOF parameters also include Quick TOF Tune. All of the TOF Autotune tools perform both automatic calibration and tuning.

Agilent Autotune for the Q-TOF also includes Initial Autotune, Checktune and Standard Tune for the quadrupole.

### Calibration

Calibration is the process of assigning accurate masses based on the known masses of standard compounds, introduced either prior to or while running the sample.

## TOF mass calibration

Any time that you want to ensure mass accuracy of the instrument, you do a calibration. You do mass calibrations by passing a calibrant with known masses from the calibrant bottle through the mass spectrometer.

## 2 Instrument Preparation

### TOF mass calibration

Before you calibrate the instrument, you have to set the instrument state to the proper instrument mode, mass range and fast polarity switching mode. You set these values on the Instrument State tab.

When you change the mass range or enable/disable fast polarity switching on the Instrument State tab, the pulser frequency is changed which results in the DEI pulser warming up or cooling down. If the calibration is performed too soon, the DEI may still be heating up or cooling down which can result in drift. See the online Help for more information on the Instrument State tab.

At startup, you do a full mass calibration, either manually or automatically. Automatic calibrations take place when you select Initial TOF Autotune, TOF Tune or Quick TOF Tune. You set up a manual calibration from the TOF Mass Calibration tab in the Tune window (Figure 20).

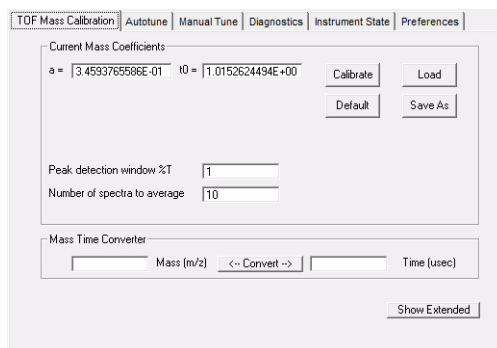

**Figure 20** Standard TOF Mass Calibration tab of the Tune window

See [Chapter 3, “Methods with Acquisition Parameters,”](#) starting on page 71, to learn more about mass correction using reference standards.

During sample analysis the system corrects the calibration with the introduction of a standard containing reference masses, if you enable the correction through the method.

The calibration equations used are proprietary.

## Tuning choices

You can see the tuning choices available to you on the Autotune tab (Figure 21). Notice that you must tune the quadrupole separately from the TOF for the Q-TOF instrument. Also, starting with the B.02.01 release, not all of the tuning choices are available with all sources.

With all instruments with the Dual ESI source, you can run all of the tuning choices, including the Standard Tune algorithm, the Initial Tune algorithm and the Set Detector Gain algorithm.

You can also run all of the tuning choices with the AJS ESI source on the Agilent 6230 UHD Accurate-Mass TOF and the Agilent 6530 and 6540 UHD Accurate-Mass Q-TOF, and the Agilent 6550 iFunnel Q-TOF.

Also, the **Instrument Mode** affects which autotunes are available to use. If the Instrument Mode is **Extended Dynamic Range (2 GHz)** mode, then you can perform any of the autotunes. If the Instrument Mode is not **Extended Dynamic Range** mode, then you can only perform Quick Tune and Check Tune. You set the **Instrument Mode** on the Instrument State tab.

With the ESI, Dual ESI, Dual AJS ESI, Multimode, APPI and APCI ion sources, you can run the Check Tune algorithm, the Quick Tune Algorithm and TOF Mass Calibration.

If Fast Polarity Switching is enabled on a Q-TOF instrument, the Quad Autotune buttons are not available.

All the automatic tuning choices calibrate the TOF using eight to ten masses, except for the 1700 mass range, which calibrates using six masses.

## 2 Instrument Preparation

### Tuning choices

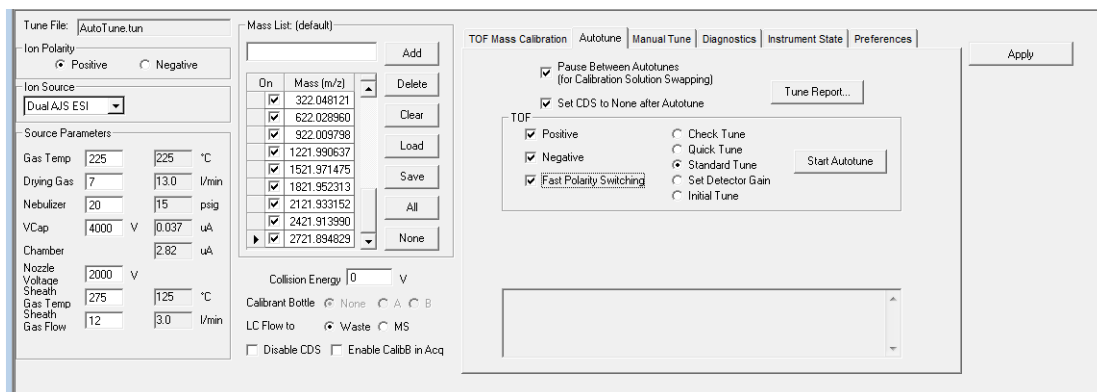

Figure 21 Autotune tab for a TOF instrument

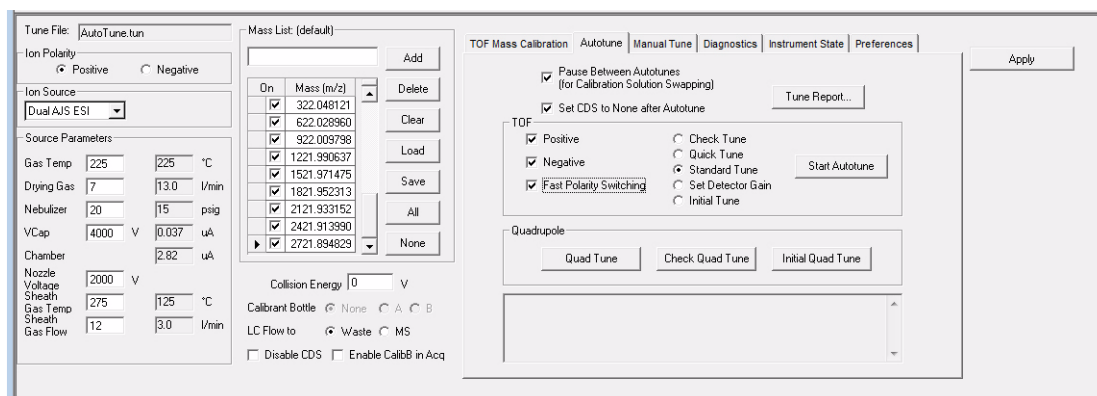

Figure 22 Autotune tab for a Q-TOF instrument

### Initial Autotune

See the *Installation Guide for instructions on how to do an Initial Autotune*

When you select this option after installation or major service, the system automatically adjusts all the tunable parameters to optimize signal, resolution and mass axis calibration.

With all Agilent 6200 TOF instruments and the Agilent 6500 Q-TOF instruments, you can perform an Initial Tune with a Dual ESI source. You can also perform an Initial Tune with the AJS ESI source on the Agilent 6230 UHD Accurate-Mass TOF and the Agilent 6530 UHD Accurate-Mass Q-TOF.

You set the Instrument Mode to Extended Dynamic Range in the Instrument State tab before running an **Initial Tune** (TOF).

You only use **Initial Tune** (TOF) or **Initial Quad Tune** under special circumstances because the process takes a long time to complete.

- After you install the hardware and software
- After your TOF analyzer has been vented for maintenance or service
- If you no longer have the previous tune files or parameters
- If Standard Autotune does not work

Instrument	Time for Initial Tune (TOF)	Time for Initial Quad Tune
Agilent 6538A, 6540A and 6550A Q-TOF	up to 60 minutes for each polarity	up to 60 minutes
Other Q-TOF instruments	up to 30 minutes for each polarity	up to 60 minutes
TOF instruments	up to 30 minutes for each polarity	N/A

During the Initial Tune process for the TOF, the system goes through the following steps without your intervention.

- a** Resets any current tune parameters to original defaults
- b** Performs a coarse TOF mass axis calibration
- c** Adjusts all the tunable parameters automatically
- d** Performs a final TOF mass axis calibration
- e** Prints a tune report at the end of the Autotune process

During the Initial Quad Tune process, the system goes through steps a, c, d and e.

### **Check Tune**

The Check Tune report lets you know if the mass calibration and optimization limits are met with a Pass or Fail.

You can perform a Check Tune with any instrument mode selected and with any of the following sources installed:

- ESI
- AJS ESI (Agilent Jet Stream ESI)
- Dual ESI
- Dual AJS ESI (Dual Agilent Jet Stream ESI)
- MMI
- APPI
- APCI

Agilent designed the instrument so that it does not need frequent autotunes. Periodically, you may want to perform a Check Tune and Check Quad Tune to ensure that the parameters are still optimized. You do not need to perform a Check Quad Tune as often as a Check TOF Tune.

### **Standard Tune**

These tools perform many of the same optimization operations as the Initial Tune tools but use the current settings as starting values and does a limited set of ion optic ramps.

With all Agilent 6200 TOF instruments and the Agilent 6500 Q-TOF instruments, you can perform a Standard Tune with a Dual ESI source. You can also perform a Standard Tune with the AJS ESI source on the Agilent 6230 UHD Accurate-Mass TOF and the Agilent 6530 UHD Accurate-Mass Q-TOF.

The Standard Tune (TOF) and Quad Tune do subsets of the Initial Tune and Initial Quad Tune actions, and they use the current tune parameters as starting points rather than using the factory defaults.

Standard Tune takes about 10 to 15 minutes, and Quad Tune takes about 10 to 15 minutes to complete.



## Quick TOF Tune

Quick Tune for TOF automatically adjusts the most commonly required subset of tunable parameters.

You can perform a Quick Tune with any instrument mode selected and with any of the following sources installed:

- ESI (with or without Agilent Jet Stream technology)
- Dual ESI (with or without Agilent Jet Stream technology)
- MMI
- APPI
- APCI

Quick Tune takes 3 to 5 minutes because the software is optimizing only the most significant parameters followed by a calibration.

During Quick Tune the system goes through the following steps:

- a Automatically opens the calibrant valve
- b Adjusts the vertical Q (Vert Q) and bottom slit parameters in the Beam Shaping Optics (optimizes transmission)
- c Adjusts the middle mirror of the compound TOF ion mirror (optimizes resolution)
- d Does a mass axis calibration after the final adjustment
- e Prints a tune report

## Set Detector Gain

Set Detector Gain adjusts the PMT voltage to obtain consistent gain (amplification) of the ion current into electrical current. In the **Extended Dynamic Range (2 GHz)** mode, it also adjusts the preamp offset values and the time delay between gain channels. This tool is a subset of Initial TOF Tune and Standard Autotune.

With all Agilent 6200 TOF instruments and the Agilent 6500 Q-TOF instruments, you can set the Detector Gain with a Dual ESI source. You can also set the Detector Gain with the AJS ESI source on the Agilent 6230 UHD Accurate-Mass TOF and the Agilent 6530 UHD Accurate-Mass Q-TOF.

You set the Instrument Mode to **Extended Dynamic Range (2 GHz)** in the Instrument State tab before running the **Set Detector Gain** algorithm.

### **Manual Tune**

See the online Help for detailed instructions to help you manually tune the TOF or Q-TOF instrument. Only perform a manual tune if the Autotune options produce a result that fails.

### **Order of using Autotune choices**

Use the tuning options in the following order:

- 1** Check Tune for the TOF  
If necessary, continue.
- 2** Quick Tune for the TOF (does not exist for the quadrupole)  
If necessary, continue.
- 3** Standard Tune for the TOF  
If necessary, continue.
- 4** Initial Tune for the TOF

Use the same order for tuning the quadrupole, if necessary.

If an initial Tune cannot complete, contact Agilent Support.

## Tune reports

At the end of every Check Tune, Quick Tune, or Standard Tune, the system generates a printable Tune report in Excel.

The TOF and Quad tune reports let you know if optimization limits are met. For a TOF tune, the report also lets you know if the mass calibration is satisfactory or not.

To print previous tune reports, you click the **Tune Reports** button in the Autotune tab.

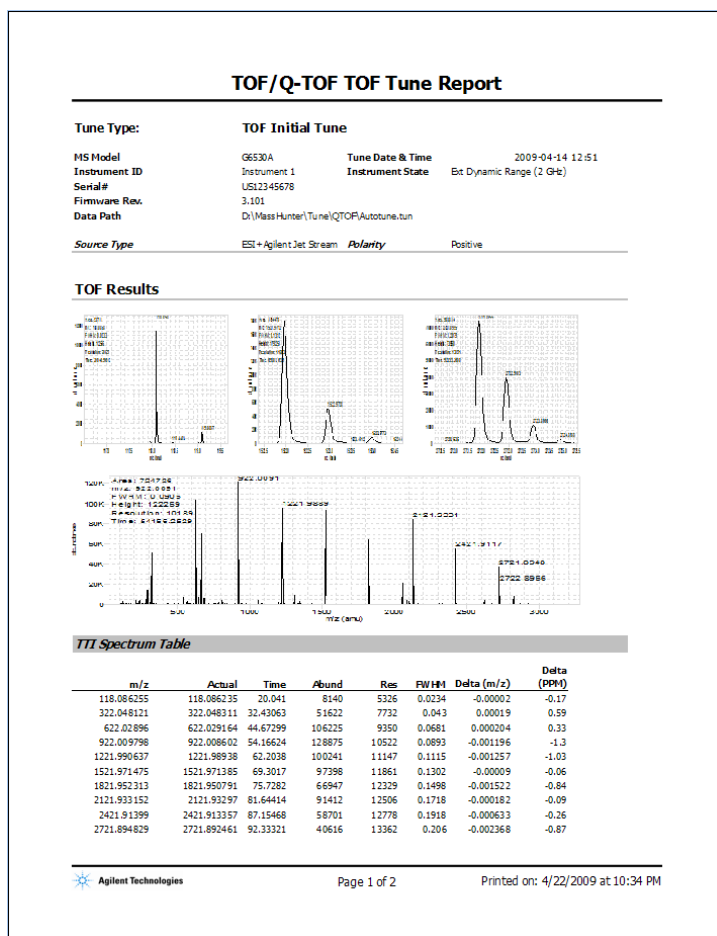

## Storage and retrieval of tune results and Instrument Mode

You can store the tuning parameters in a single file (\*.tun) using the **Save** or **Save As** buttons in the Instrument State tab. You can also load tune files in the Instrument State tab (Figure 23). The Mass Range, the Fast Polarity Switching option and the Instrument Mode are also stored in the tune file.

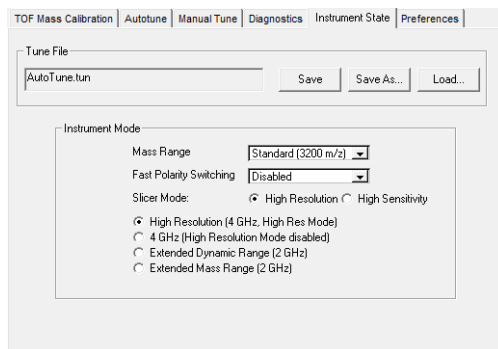

**Figure 23** Instrument State tab

### Instrument Modes

You select from four different instrument modes.

**High Resolution (4 GHz, High Res Mode)** In this mode, the system acquires data at a 4 GHz ADC rate while special processing is performed in real time on the mass peaks detected in each transient, weighting the apex data of the mass peaks much more heavily than the shoulders. This leads to narrower peaks in the summed transients (the mass spectra) and hence improves resolution. The Mass Range can only be set to Low (1700 m/z) or Standard (3200 m/z) if the Instrument Mode is set to this value.

**4 GHz (High Resolution Mode disabled)** In this mode, no processing is used at the transient level; however, the system acquires data at a 4 GHz ADC rate. The Mass Range can only be set to Low (1700 m/z) or Standard (3200 m/z) if the Instrument Mode is set to this value.

**Extended Dynamic Range (2 GHz)** In this mode, the system acquires data at a 4 GHz ADC rate in dual channel mode. One channel is recorded at a high detector gain while the other channel operates at a low detector gain. The firmware stitches the two channels together to produce a scan with a sampling rate of 2 GHz, which results in a greatly increased dynamic range. The Mass Range can only be set to Low (1700 m/z) or Standard (3200 m/z) if the Instrument Mode is set to this value.

**Extended Mass Range (2 GHz)** In this mode, the system acquires data at a 2 GHz ADC rate. The Mass Range can be set to Low (1700 m/z), Standard (3200 m/z) or High (10,000). This is the only mode that you can use with the highest mass range.

## Tune Set Point Modifications for Medium and Large Proteins

For medium and large proteins, the charge envelope may extend beyond 3200 m/z. It is recommended that you acquire your intact protein data in the Minimum Storage Size mode on the Agilent 6200 Series TOF and Agilent 6520/6530 Q-TOF as this allows the extended mass range needed for larger proteins. If you are acquiring a protein and the charge states are “cut-off” in one of the other modes, you can switch to this mode with the extended mass range.

If you are acquiring medium and large protein data, it is also recommended that the Quad AMU be raised to 300 amu instead of using the value established by the Auto Tune algorithm. This provides the Quad with enough power to transmit the high mass ions through the quad. Failure to increase the Quad AMU will result in a mass spectrum where the charge envelope appears to be “cutoff” for the higher charge state ion clusters.

To adjust the Quad AMU, do the following steps:

- 1 Switch to the Tune Context.
- 2 Click the **Manual Tune** tab.
- 3 Click the **Quad** Tab.
- 4 For the **Quad AMU**, type 300 for the new value.
- 5 Save the tune value to save the new **Quad AMU** value. Then exit the Tune Context.

## Real-time displays

### Instrument Status Window

The Instrument Status window is also called the Dashboard. You can see if a module is On, Off or in Standby by observing the color of the bar in the title for each device pane. The title bar also includes words describing the current state of each device. The Instrument Status Bar appears at the bottom of the Instrument Status window. You can see the overall state of the Instrument in this Instrument Status Bar.

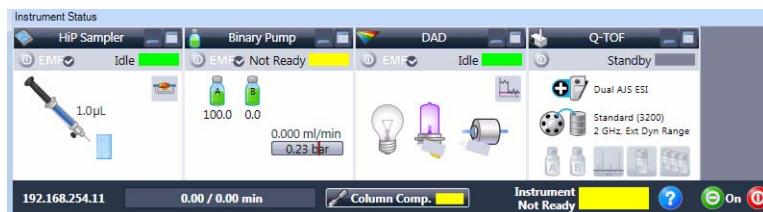

**Figure 24** Instrument Status window

**Table 2** Colors of Instrument States

Instrument State	Color
On—Preparing/Not ready	Yellow
On—Ready	Green
On—Waiting, Pre-run or post-run	Purple
On—Running, Injecting	Blue
Standby	Light Gray—To see if the pump, TOF or Q-TOF is in Standby mode or off, you can also look for the check mark in the shortcut menu.
Off	Dark Gray
Error condition	Red

## Real-time parameter values (Actuals)

### What you can display

You select parameters and states to monitor for each instrument module in the Actuals window.

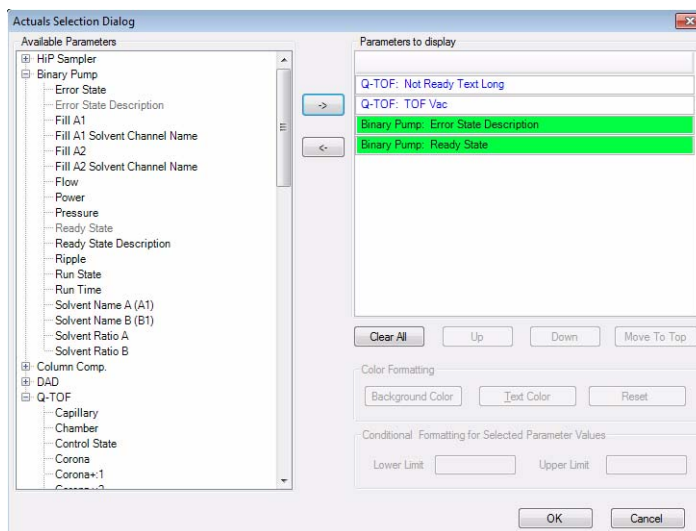

Figure 25 Actuals Selection dialog box



The parameters and states for each module listed below are available for display.

*See the online Help for descriptions of each of these parameters and states.*

**Table 3** Actuals available for display

Module	Parameter or State
All modules	Run Time, Run State, Ready State, Ready Type, Not Ready Text Long, Not Ready Text Short, Rawdata State, Error State
ALS	Vial, Sample, Volume, Needle, Command, Injectmode, Tray Type A, Tray Type B, Overlap, Injectstatus, Temp, Therm Power
WPS, $\mu$ WPS, h-ALS, h-ALS-SL and h-ALS-SL+	The same as ALS except no Vial and addition of Drawn Volume, Sample Position and Needle Position
Binary Pump	Solvent Ratio A, Solvent Ratio B, Flow, Pressure, Ripple, Fill A,B, A1, B1, A2, B2, Power, Channel Name A, B, Solvent Selection A, B
Capillary Pump	Same as binary pump with no Fill A1, A2, B1, B2 and with the addition of Solvent Ratio C, Solvent Ratio D, Fill C, Fill D, Primary Flow, EMPV, Purge Status, Purge Channel, Purge Time and Pump Op Mode
Nanopump	Same as capillary pump with addition of FSAC State and FSAC Step. FSAC stands for Flow Sensor Accuracy Calibration. When you click the Accuracy Calibration shortcut menu, these values show you the status of the step in the test procedure.
Thermostatted Column Compartment	Left Temp, Left Temp Set, Right Temp, Right Temp set, Column Valve, Therm Power
35900E	Current Vial
DAD G1315C, G1315D, G4212A, G4212B, G1365C and G1365D	Sample WI A-H, Sample Bw A-H, Reference On A-H, Reference WI A-H, Reference Bw A-H, UV Lamp, Vis Lamp

## 2 Instrument Preparation

### Real-time Chromatogram Plot and Spectral Plot windows

**Table 3** Actuals available for display

Module	Parameter or State
DAD G1315A, G1315B, G1365A, and G1365B	Sample WI A-E, Sample Bw A-E, Reference On A-E, Reference WI A-E, Reference Bw A-E, UV Lamp, Vis Lamp
TOF or Q-TOF	Rough Vacuum, High Vacuum, Gas Temp, Vaporizer Temp, Drying Gas Flow, Nebulizer Pressure, Capillary Current, Chamber Current, Corona Voltage, Charging Voltage, Control State, Cal/Ref Mass, LC Stream

## Real-time Chromatogram Plot and Spectral Plot windows

### What you can display

You can display plots in the Chromatogram Plot window and in the Spectrum Plot window.

**Table 4** Chromatogram plots available for display

Module	Plot type
Pumps	Pressure vs. time
Thermostatted Column Compartment	Temperature Left, Temperature Right vs. time
35900E	ADC signal vs. time
DAD	Signals A-H vs. time
TOF or Q-TOF	Any chromatogram set up in the Chromatogram tab of the Method Editor window: <ul style="list-style-type: none"><li>• Any segment or scan of a total ion chromatogram (TIC) or extracted ion chromatogram (EIC)</li><li>• Method set points and actual conditions</li></ul>

## What you can do with the displays

**Table 5** What you can do with plots and spectra

Display type	What you can do
Signal plots	Change range of intensity or time, freeze and zoom the plot
Pump parameters	Change range of intensity or time, freeze and zoom the plot
TOF or Q-TOF spectra	Autoscale the axes, freeze and zoom the plot; toggle between a line spectrum and a profile spectrum; toggle between a mass x-axis and a time x-axis, change to a display of DAD spectra (from line spectra only)

## Profile vs. Centroid spectral displays

Centroid spectra for the TOF and Q-TOF display the abundance vs. mass for the calculated centroid of the peak. Profile spectra display the abundance vs. mass over the mass range of the peak.

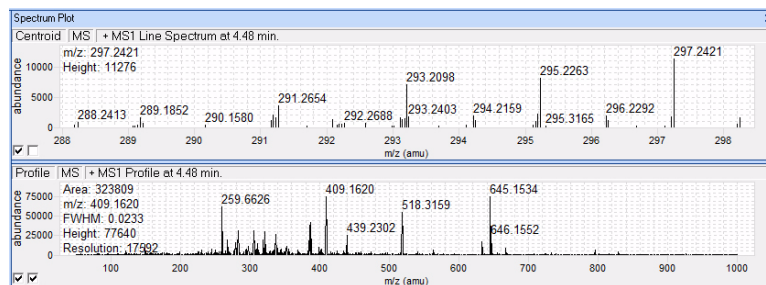

**Figure 26** Centroid and profile plots in the Spectrum Plot window

The default display is to plot abundance vs. mass, but you can change the x-axis to time. To do this, right-click the Spectrum Plot window and click **Show Time** from the shortcut menu. Click **Show Mass** to return to the Abundance vs. Mass plot.

## System logbook

*The system logbook does not list any changes to a method or worklist.*

### What you can view in the system logbook

The Logbook Viewer displays the dates and times when system events take place:

- Run starts, stops and aborts
- Method loaded
- Tuning and calibration operations
- Unexpected software errors
- Device driver errors, warnings and alerts including leak detection, vial not found, lamp burned out
- Device powered off or reconfigured
- Start up and shutdown
- Worklist events
- Method log files

When you open the Logbook Viewer, the software loads and displays the most recent entries in the log file.

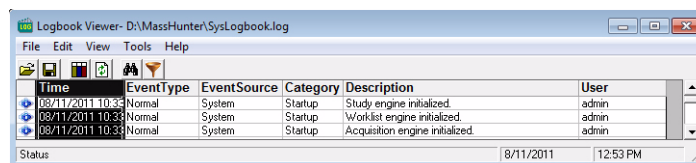

**Figure 27** Logbook Viewer

The logbook also displays additional information about each event. Since the display of individual columns can be turned on and off, not all of these columns may be visible at any given time.

**Table 6** Columns available for display in the Logbook Viewer

Column Name	Description
Time	Date and time of the event
Event Type	Normal event or error
Event Source	The module that produced the event (Worklist, Instr Mgr, App UI, Launcher, DA Mgr)
Category	More information about the event (e.g. Startup, Shutdown, Worklist Start, Worklist End, Run Started, Run Stopped, Run Aborted, Method Loaded)
Description	More information about the event
User	Name of the user who started the acquisition engines when the event occurred

### What you can do with the system logbook

*Move the cursor over an icon to see the tooltips, which help you perform the correct task.*

*See the online Help for instructions on how to work with the logbook.*

The system deletes logbook entries that are older than the value set in the **System logbook purge** dialog box. You can select a value from 1 day to 2 weeks. You click **Tools > Purge Settings** to display this dialog box.

A copy of the logbook is automatically archived in the \MassHunter\Log\Acq\Archive\Logbook folder. If you want to view an archived logbook, click **File > Open** in the Logbook Viewer program and select the *.log* that you want to view. You can also save the logbook at any time by clicking **File > Save Logbook As**.

Most of the tasks that you can do with the logbook help you view the entries you need to see more easily.

**Table 7** Tasks you can perform with the logbook

If you want to do this:	Click this menu item or icon:
View an individual entry	Edit > Search
View selected entries only	Edit > Filter
Change column types and size	View menu

**Table 7** Tasks you can perform with the logbook

<b>If you want to do this:</b>	<b>Click this menu item or icon:</b>
View recent events	View > Refresh
Archive entries	File > Save or Shortcut menu > Export
Open, close, or save the logbook	File menu
View method log files (method.log file in the Acq. or DA method folder)	File > Open
Print the logbook	Shortcut menu > Export

### Notification through the Taskbar

You can configure the system logbook to automatically display messages from the taskbar. You can specify the type of messages to display and how many messages to display at a time. By default, this feature is disabled. To enable automatic logbook notification, right-click on the Logbook icon in the Taskbar and click **Configure**. After you have selected how many messages to display and the type of messages, you then right-click the logbook icon in the system tray and click **Enable Notification**. Messages are still saved in the logbook whether or not you have enabled automatic notification.



## 3 Methods with Acquisition Parameters

- Parameter entry [72](#)
  - General TOF and Q-TOF parameters [76](#)
  - TOF and Q-TOF acquisition parameters [79](#)
  - Ion source parameters [76](#)
  - Setup of TOF and Q-TOF reference mass correction (recalibration) [86](#)
  - TOF and Q-TOF chromatogram setup [90](#)
- Method saving, editing and reporting [91](#)
  - Saving a method with data acquisition parameters [91](#)
  - Method editing [93](#)
  - Method reporting [94](#)

*See the online Help for instructions on setting up methods and parameter descriptions.*

You use this chapter to learn about the concepts that can help you set up methods containing data acquisition parameters.



### 3 Methods with Acquisition Parameters

#### Parameter entry

## Parameter entry

### LC parameter entry

Most of the LC parameter entries are the same as those that you can change with the Agilent 1200 LC control module and with other Agilent software products, such as Agilent ChemStation.

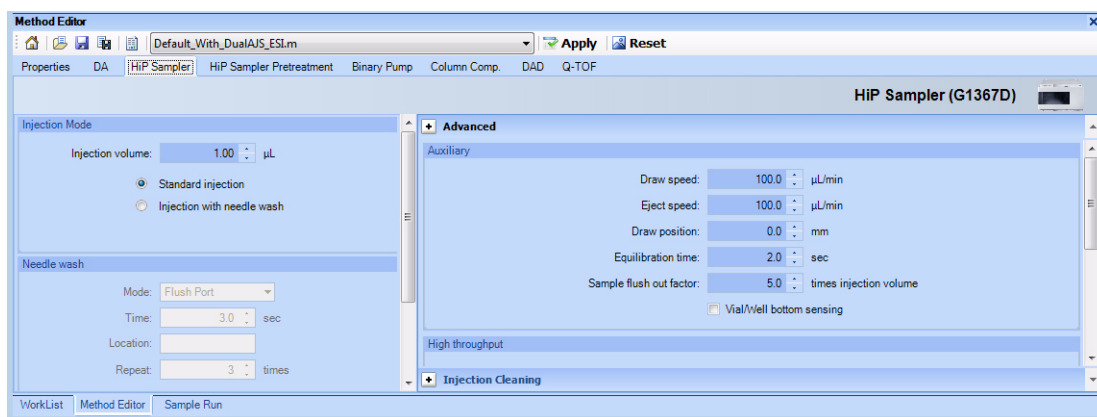

Figure 28 LC parameter entry in the Method Editor window

### TOF and Q-TOF parameter entry

Even though parameter entry is straightforward for the TOF and Q-TOF, the background information in this section can help you make the correct entries to produce the best results.

- Automatic parameter changes during a run
- General TOF and Q-TOF parameters
- Ion source parameters
- TOF and Q-TOF data acquisition parameters
- Setup for reference mass correction (recalibration)
- TOF and Q-TOF chromatogram setup



## Automatic TOF and Q-TOF parameter changes during a run

The screenshot shows the 'General' tab of the Method Editor window. The 'Ion Polarity (Seg)' section has 'Positive' selected. 'Fast Polarity Switching' is unchecked. The 'Data Storage (Seg)' section has 'Both' selected. The 'LC Stream (Seg)' section has 'MS' selected, with an 'Apply Now' button below it. The 'Plot and Centroid Data Storage Threshold' section is divided into 'MS' and 'MS/MS' columns. Under 'MS', 'Abs. threshold' is 200 and 'Rel. threshold (%)' is 0.01. Under 'MS/MS', 'Abs. threshold' is 5 and 'Rel. threshold (%)' is 0.01. A checkbox at the bottom is labeled 'Do not wait for setpoints (e.g. temperature) to equilibrate'.

**Figure 29** Q-TOF parameter entry in the Method Editor window

## Automatic TOF and Q-TOF parameter changes during a run

You can set some TOF and Q-TOF method set points to be different at different points in time during the run. The different time points in the method are called time segments. Within each time segment, you can have different sets of parameters, called experiments.

Many parameters can be changed for different time segments. Some parameters can be changed for different experiments in the same time segment. For example, the gas temperature, drying gas flow rate, and the nebulizer pressure must be the same for all experiments in the same time segment, but fragmentor and capillary voltages can be different for different experiments.

### 3 Methods with Acquisition Parameters

#### Automatic TOF and Q-TOF parameter changes during a run

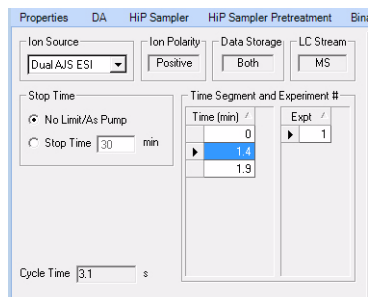

**Figure 30** Location for setup of Time Segments and Experiments

Per time segment set points are labeled with (*Seg*). Per experiment set points are labeled with (*Expt*). All other set points are per run. These set points can be found in these tabs.

- General Tab
- Source Tab
- Acquisition Tab

#### Acquisition tab

You can set up time segments for changing these parameters.

**MS mode** The MS mode spectral parameters can be set for each time segment.

**Auto MS/MS mode (Q-TOF only)** The parameters on the following tabs can be set for each time segment:

- MS Q-TOF Spectral Parameters Tab
- MS Q-TOF Collision Energy Tab
- MS Q-TOF Precursor Selection I Tab
- MS Q-TOF Precursor Selection II Tab
- MS Q-TOF Preferred/Exclude Tab

**Targeted MS/MS mode (Q-TOF only)** The parameters on the following tabs can be set for each time segment:

- MS Q-TOF Spectral Parameters Tab

**Automatic TOF and Q-TOF parameter changes during a run**

- MS Q-TOF Collision Energy Tab
- MS Q-TOF Targeted List Tab

See [“TOF and Q-TOF acquisition parameters”](#) on page 79 for a description of the TOF, Auto MS/MS and Targeted MS/MS modes and their parameters.

## General TOF and Q-TOF parameters

You enter general TOF and Q-TOF parameters on the General tab of either the MS TOF tab or the MS Q-TOF tab in the Method Editor window.

The screenshot shows the 'General' tab of the Q-TOF Method Editor. The 'Ion Polarity (Seg)' section has 'Positive' selected. The 'Data Storage (Seg)' section has 'Both' selected. The 'LC Stream (Seg)' section has 'MS' selected. The 'Plot and Centroid Data Storage Threshold' section has 'Abs. threshold' of 200 and 'Rel. threshold (%)' of 0.01 for MS, and 'Abs. threshold' of 5 and 'Rel. threshold (%)' of 0.01 for MS/MS. A checkbox at the bottom is unchecked.

**Figure 31** General tab of the Q-TOF Method Editor window

### Profile vs. centroid spectra

You can save mass spectral data as whole peaks over the mass range of the peak, or you can save only the data for the mass whose intensity appears in the “middle” of the peak. To limit the number of peaks whose centroid data are saved or appear in the Spectrum Plot window (line spectra), you can set an absolute or relative threshold for both MS and MS/MS data.

### Ion source parameters

*See the online Help to view recommended parameter values for each ion source.*

You can use several different sources with the Agilent TOF and Q-TOF LC/MS system:

- ESI
- AJS ESI
- Dual ESI
- Dual AJS ESI
- APCI

- APPI
- AP-MALDI
- PDF-MALDI
- Orthogonal Nanospray
- HPLC-Chip/MS interface
- Dual Orthogonal Nanospray
- MMI

Each of the sources uses different parameters for controlling the ion source. The default parameters are set for an electrospray source. When you select a new ion source in the Method Editor window, you see new parameter options and boxes under the Source tab in the MS TOF tab or the MS Q-TOF tab.

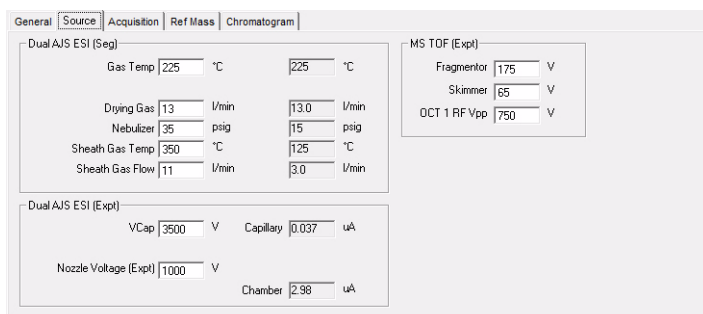

**Figure 32** Ion source parameters in the Method Editor window

### 3 Methods with Acquisition Parameters

#### Ion source parameters

*For instructions on how to set up and run samples with the AP-MALDI and PDF-MALDI inlet and ion source, see the online Help.*

*For instructions on how to install the AP-MALDI or PDF-MALDI ion source, see the Installation Guide.*

*Before the AP-MALDI or the PDF-MALDI is installed, in the instrument configuration tool, the LC must be removed from the system configuration.*

*For more information on how to set up the AP-MALDI to introduce samples, refer to the Agilent G1972A AP-MALDI LC/MSD Trap SL System User Guide.*

#### Tips for using the AP-MALDI or PDF-MALDI source

- Tune the TOF or Q-TOF with an ESI source installed
- Make sure the Run Type in the Sample Run window is set to External Start.
- Set the proper settings in the AP-MALDI or PDF-MALDI control software, and make sure that the desorption time is not less than the MS TOF stop time.

Autotune for the AP-MALDI and PDF-MALDI source is not supported.

## TOF and Q-TOF acquisition parameters

The Acquisition tab in [Figure 33](#) contains acquisition parameters that you can change with time segments.

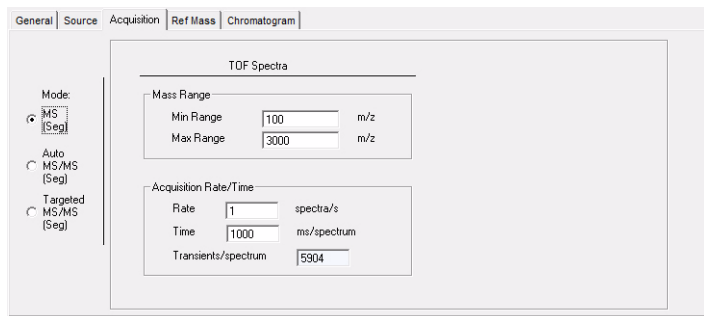

**Figure 33** Acquisition tab in the Method Editor window

The acquisition parameters you choose depend on what you are trying to accomplish:

- If you want to pass all ions in a specified mass range through the instrument with no fragmentation in the collision cell, click **MS (Seg)** mode. This mode is automatically chosen for a TOF instrument.
- If you don't know what you are looking for and must set up boundary parameters for the precursor ion list, click **Auto MS/MS (Seg)** mode.
- If you know the compounds and hence the precursor ions you are looking for, click **Targeted MS/MS (Seg)** mode.

## MS mode

In this mode the Q-TOF instrument behaves solely as a TOF instrument with no quad isolation applied. You specify the mass range and the acquisition rate and time to collect spectra.

The screenshot shows the 'Acquisition' tab of the software interface. On the left, there is a 'Mode' section with three radio buttons: 'MS (Seg)' (selected), 'Auto MS/MS (Seg)', and 'Targeted MS/MS (Seg)'. The main area is titled 'TOF Spectra' and contains two sections: 'Mass Range' and 'Acquisition Rate/Time'. The 'Mass Range' section has two input fields: 'Min Range' with the value '100' and 'Max Range' with the value '3000', both followed by 'm/z'. The 'Acquisition Rate/Time' section has three input fields: 'Rate' with the value '1' and 'spectra/s', 'Time' with the value '1000' and 'ms/spectrum', and 'Transients/spectrum' with the value '5904'.

Figure 34 MS mode parameters in the Acquisition tab

**Transients vs. mass range** The mass spectrum resulting from a single pulse of voltage applied to the ion pulser is called a *transient*. The recorded Mass Spectrum is, in reality, a result of the application of multiple pulses to the ion pulser and a summation of lower signal mass spectra, or transients. (Figure 35)

For analyses that require one Mass Spectrum or scan per second, the Agilent TOF and Q-TOF LC/MS software sums 10,000 transients before transferring the data from the instrument back to the host computer to be written to disk. If the target application involves high speed chromatography and requires faster scanning, you can reduce the number of transients per scan to increase the scans per second.

The *length of transients* is the time the system is allowed to collect data for the transient in nanoseconds. On the Agilent TOF and Q-TOF LC/MS, three mass range modes are available:

- Low (1,700  $m/z$ )
- Standard (3,200  $m/z$ )
- High (20,000  $m/z$ ) - The mass range of 20,000  $m/z$  is available for Accurate-Mass TOF and Q-TOF instruments.



The transient length is set appropriately for each of these modes.

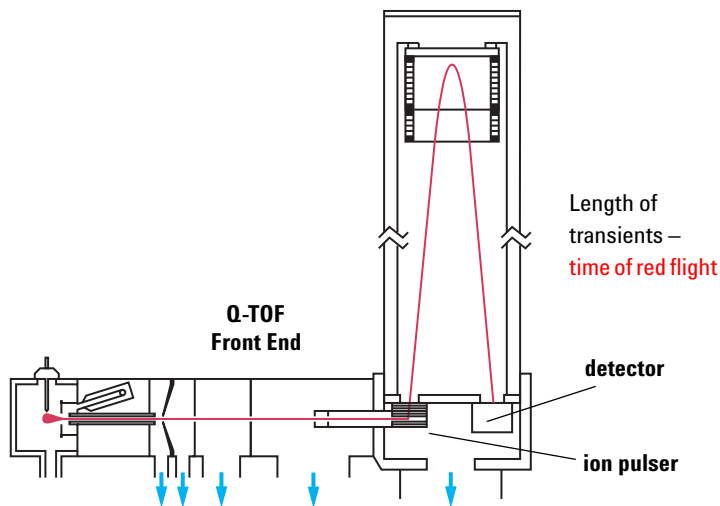
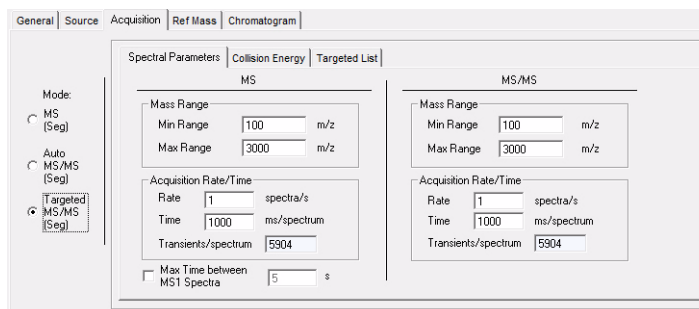

**Figure 35** Length of transients is measured from the ion pulser to the detector

### Targeted MS/MS mode (Q-TOF only)

In this mode you specify the precursor ion that you want the quadrupole to select and pass through to the collision cell for fragmentation. The TOF portion of the instrument then passes all the product ions through to the detector, and you select the ion you want to look at in the spectrum produced by the TOF.

### 3 Methods with Acquisition Parameters TOF and Q-TOF acquisition parameters



**Figure 36** The Spectral Parameters tab for Targeted MS/MS mode

**Spectral Parameters** These parameters are the same as those for the TOF mode, but they are applied to both the quad (MS) and the TOF components (MS/MS).

**Collision Energy** You can enter multiple fixed collision energies (each collision energy is used), the slope and offset of a line, or a table of collision energies.

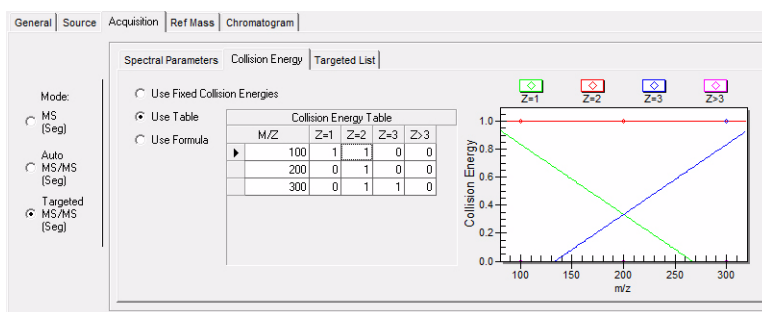

**Figure 37** The Collision Energy tab for Targeted MS/MS mode

For general method development you set the slope and offset for a curve whose collision energy the system selects to match the precursor ion,  $m/z$ , on the curve.

**Targeted List** For compounds for which you already know the precursor ions, you can place the collision energy in the targeted list for the precursor ion and vary its value to optimize the abundance of the product ion.

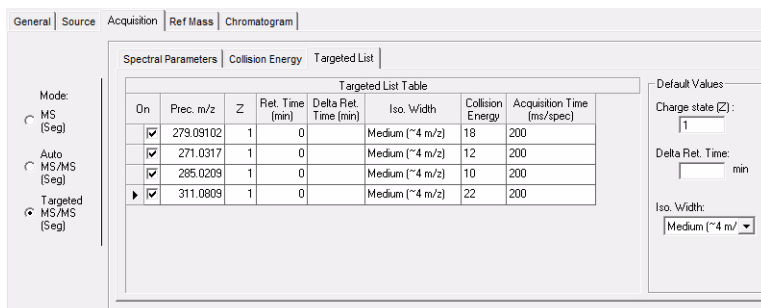

**Figure 38** Targeted List tab for Targeted MS/MS mode

The collision energies specified here override the values specified in the Collision Energy tab.

### Auto MS/MS (Q-TOF only)

In Auto MS/MS mode, two additional tabs appear: Precursor Selection I and Precursor Selection II.

The Spectral Parameters tab contains the same parameters as in Targeted MS/MS mode. The other four tabs are used to enter the boundary parameters for selecting precursor ions.

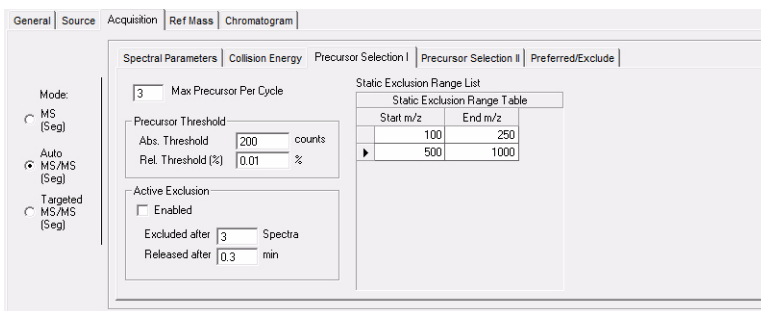

**Figure 39** Auto MS/MS mode with Precursor Selection 1 tab selected

### 3 Methods with Acquisition Parameters

#### TOF and Q-TOF acquisition parameters

The software sorts a list of possible precursor ions whose order depends on the boundary parameters entered:

- a** Passes all ions through (TOF only) and sorts the list from highest abundance to lowest (or by charge then abundance)
- b** Excludes those masses in the specified mass range
- c** Sorts the list based on the priority of charges
- d** Moves preferred ions to the top of list in the order specified
- e** Chooses the top ions on the list based on the entry for maximum number of precursor ions per cycle (Max Precursor per cycle)
- f** Excludes masses after a specified number of spectra have been acquired and releases the exclusion after a specified time (Active Exclusion)

### Varying scan speed based on precursor abundance

You can adjust the number of transients as a function of the precursor intensity. Varying the scan speed is very useful when you have a complex sample, such as a protein digest. To use this feature, you mark the **Scan speed varied based on precursor abundance** check box on the Precursor Selection II tab.

When this feature is turned on, the MS/MS acquisition rate is automatically adjusted based on precursor intensity, thus spending less time on the more abundant peptides and more time on the less abundant peptides. This should improve MS/MS quality and hence database matching.

The variable MS/MS acquisition mode can result in one or more additional precursors being examined per scan cycle as less time is spent on more abundant precursors.

See the online Help for information on Abundance Dependent Accumulation and Purity.

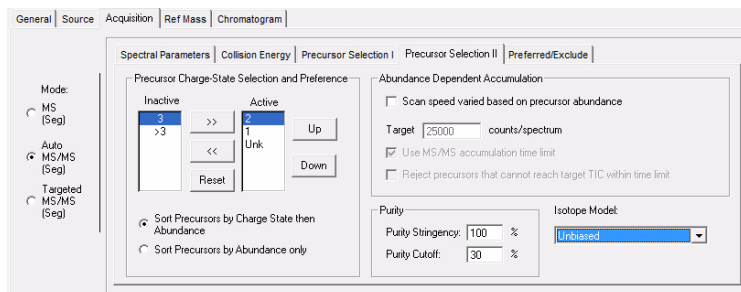

**Figure 40** Auto MS/MS mode with Precursor Selection II selected

### 3 Methods with Acquisition Parameters

#### Setup of TOF and Q-TOF reference mass correction (recalibration)

## Setup of TOF and Q-TOF reference mass correction (recalibration)

*You must do mass corrections during a run in order to attain the mass accuracy that Agilent specifies for the TOF and Q-TOF.*

Many applications need as small a deviation of accurate mass as possible. To obtain this accuracy, you recalibrate the mass axis for every spectrum with measurements of known reference masses (i.e. “lock masses”). You measure the masses of reference compounds in a reference standard, which can be the Agilent reference standard or one of your own choosing.

You can introduce the reference standard into the TOF system in one of three ways:

- A calibrant delivery system (CDS) that automatically introduces the standard to a reference sprayer (second sprayer)— Dual ESI (0.2 to 1.5 mL/min flow rates only) and Dual AJS ESI and Dual nano ESI
- An external dispense pump—other ion sources
- Addition to the sample—other ion sources

You can also use known ions in your sample, such as the “y1” in a tryptic digest, as a supporting reference mass.

## Enabling reference mass correction

You set up and enable reference mass correction in the Ref. Masses tab within the MS TOF tab or the MS Q-TOF tab of the Method Editor window.

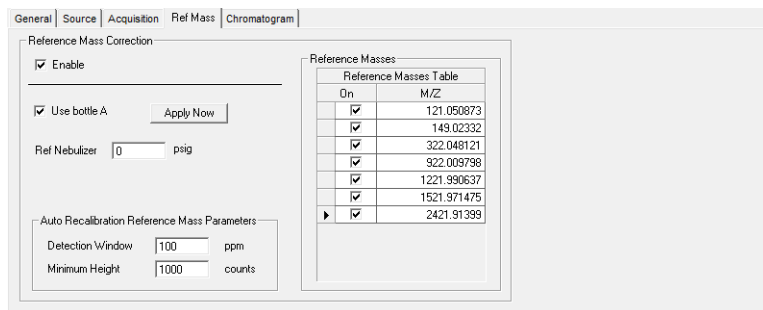

**Figure 41** Reference Masses tab

If you mark the **Enable** check box, the system uses reference masses of the mass reference standard for automatic recalibration of each acquired spectrum.

You must select the reference masses for each polarity in the method. Reference masses are not only ion source dependent, but also polarity dependent. To adjust both the  $a$  and  $T_0$  terms requires at least two reference masses, spread across the application mass range, such that the first reference mass is  $<330$   $m/z$  and the second is  $500$   $m/z$  or more above the first. Using more reference masses improves recalibration results. Up to 20 masses can be selected.

The reference masses specified for the method will be stored with the method. These reference masses are also stored in the file with acquired data as TOF or Q-TOF method parameters.

If you mark the **Use Bottle A** check box, the TOF or Q-TOF controls the valve to introduce the internal reference standard to the reference sprayer via the CDS.

The **Ref Nebulizer** parameter is only available if the source is either Dual ESI, Dual AJS ESI or Dual nanoESI.

### 3 Methods with Acquisition Parameters

#### Setup of TOF and Q-TOF reference mass correction (recalibration)

*To learn more about the underlying calibration equation and coefficients, see “TOF mass calibration” on page 51.*

#### Number of required reference masses

With two unknowns, a minimum of two known values are required to determine both  $A$  and  $t_0$ . Practical considerations also come into play. In order to get a good fit for both  $A$  and  $t_0$  then at least one reference mass needs to be at a low mass value and there needs to be at least one reference mass at a higher mass. Standard analytical practice also suggests that the low  $m/z$  and high  $m/z$  reference masses bracket the masses of interest.

Specifically, the reference mass correction algorithm requires that one mass be at or below  $m/z$  330 with a second mass that is at least 500  $m/z$  above the low mass ion in order to correct  $t_0$  and  $A$  terms. If these conditions are not satisfied but at least one reference mass is found, then only the  $A$  term will be re-calibrated.

#### Selecting/editing list of reference masses

When creating a new method, the Agilent MassHunter Workstation Software provides separate lists of reference masses for each polarity. You can use the already provided mass list, or you can create or edit a new mass list by right-clicking the arrow to the left of each row in the Ref Mass tab.

#### Parameters for a reference mass correction

*To know more about Segments and Experiments, see “Automatic TOF and Q-TOF parameter changes during a run” on page 73.*

**Scans To Average** To increase the accuracy of the reference mass correction, you can use a running average of the reference mass values across several spectra. These mass values are used in determining the corrected calibration coefficients. The default number of spectra used is five. Only odd values are allowed.

The software averages only spectra from the same scan group, and therefore a spectral average spans a spectral cycle. A spectral cycle contains one spectrum for each of the Experiments defined in a given Segment.



For example, if a Time Segment contains one Experiment with Fragmentor voltage at 225V and another Experiment with Fragmentor voltage at 200V, then a spectral cycle will contain two successive spectra, one at 225V and another at 200V.

Spectra from scans of different fragmentor voltage (or other scan specific parameters) should not be summed and averaged because they yield different masses.

**Example** The “Scans To Average” is 5. If the spectrum of interest is in the *n*th cycle, then spectral data of the same Fragmentor voltage from *cycles* *n*-2, *n*-1, *n*, *n*+1, *n*+2 are used in the average with equal weights. If this Time Segment has defined one Fragmentor voltage of 225 Experiment #1, and one Fragmentor voltage of 220 Experiment #2, and the current spectrum is the Fragmentor voltage of 225 Experiment #1 of the *n*th cycle, the *spectra* *n*-4, *n*-2, *n*, *n*+2, *n*+4 will be used for the average.

**Reference Mass Window** When the software attempts to find the reference mass, it searches for the highest spectral peak in the defined reference mass window, which is the window width in parts per million (ppm). Recalibration using reference masses of the internal reference standard does not replace normal or external mass calibration. You must set the window for recalibration small enough so the software does not pick a spectral peak from the sample as the reference mass peak. 100 ppm is the recommended default value.

**Reference Mass Minimum Height** The “Reference Mass Minimum Height” is the abundance in counts. The software uses this height to exclude noise peaks and peaks of reference masses that may fall within the detection window but that are too small to be used for calibration. This is especially important if you use reference masses that may be present in the tryptic digest, such as the *y*<sub>1</sub> ion (*m/z* 147 for N-terminal Lys or *m/z* 175 for N-terminal Arg), but may not be present in all spectra in the run. Signals below 1,000 counts are generally too low to be used. Signals above 75,000 counts for the reference mass ion can negatively affect the reference mass correction.

## TOF and Q-TOF chromatogram setup

In the Chromatogram tab, you also select the chromatograms or the set points/actuals that you want to see in the Chromatogram Plot window during the run.

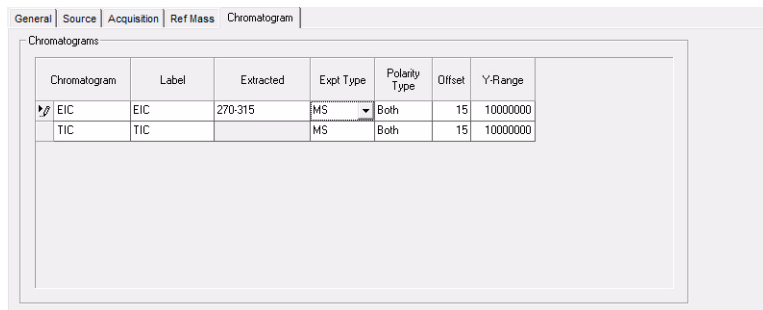

**Figure 42** Chromatogram tab in the TOF or Q-TOF tab

You can select the signal to plot (TIC, EIC, BPC, Set point, Actual), the experiment type, the offset of the baseline for the plot and the valid range of values in counts. You can also set the mass range for the EIC.

## Method saving, editing and reporting

### Saving a method with data acquisition parameters

#### Adding pre- or post-run scripts before saving

*To learn how to set up scripts, see your Agilent application engineer.*

Before you save a method, you can enter the pathway for the customized scripts that start before or after a run. You do this on the Properties tab.

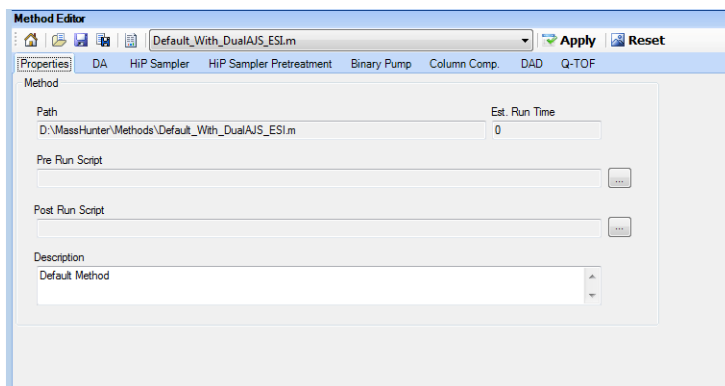

**Figure 43** Properties tab of the Method Editor window

Scripts can be written using any programming language. Scripts provided by Agilent should not be modified since these files may be overwritten when upgrading the Agilent software.

*For more information on scripts, see the online Help.*

Below is a list of scripts that Agilent includes with the software and that you can use with both methods and worklists.

### 3 Methods with Acquisition Parameters

#### Saving a method with data acquisition parameters

**Table 8** System scripts and the actions they enable

Script name	Actions the script enable
SCP_AcquireCalibrantData	Sets "Cal/Ref Mass" to "Cal B" and "LCStream" to "LC->Waste". Allows you to acquire data for the calibrant solution itself. To be used only as the Pre-run script for a method. The script itself does <i>not</i> do a run and only augments an existing method. Do not use as a standalone script in a worklist run.
SCP_MSDivertValveToMS	Sets the solvent divert valve to the "MS" position.
SCP_MSDivertValveToWaste	Sets the solvent divert valve to the "Waste" position.
SCP_InstrumentStandby	Puts the instrument in standby mode. This is the same as clicking the "Standby" button on the Instrument Status window.
SCP_LoadIdleMethod (MethodName)	Loads a method to put the system in an idle state. The first parameter is the method name.
SCP_MSRefOff	Turns off the MS reference ion solution (Ref A)
SCP_PumpsAllandMSRefOff	Turns off LC pumps and turns off the MS reference ion solution.
SCP_PumpsAllOff	Turns off all pumps.
SCP_LCCondition (MethodName, LCStream)	Starts a run for conditioning the LC part of the instrument. No data acquisition happens.
SCP_CalibrateTOFMassAxis	Starts a TOF/Q-TOF mass axis calibration in the active polarity using the default mass list
SCP_TraceOnOff	Switches the trace to ON or OFF. The first parameter must be either "on" or "off".
SCP_ClearTrace	Clears the trace file.

**Table 8** System scripts and the actions they enable

Script name	Actions the script enable
SCP_ProcessQuantReport	Runs a single sample Quant report. Quantitative Analysis must be installed. Use only as a Post Method script.
SCP_CTCReset	Resets the CTC autosampler. If a drawer is open, it will be closed.

### Location of method folders

You can save methods to any folder on the system. The default folder is **D:\MassHunter\Methods\**.

You can view the name and path of the currently loaded method in the Properties tab of the Method Editor window (Figure 43).

## Method editing

You can edit methods containing data acquisition parameters using the Method Editor window of the Data Acquisition software.

Use this location for method development. The set points are sent to the instrument when the method is loaded or when you click the **Apply** button after changing a parameter.

Methods can also contain Qualitative Analysis and Quantitative Analysis parameters. You can modify the Qualitative Analysis and Quantitative Analysis parts of the method in the DA tab in the Method Editor window. See the *Agilent MassHunter Workstation Software Qualitative Analysis Familiarization Guide* or the online Help for the Qualitative Analysis program for more information on the Qualitative Analysis software. See the *Agilent MassHunter Workstation Software Quantitative Analysis Familiarization Guide* or the online Help for the Quantitative Analysis program for more information on the Quantitative Analysis software.

## Method reporting

You can see the parameters in a method in one of three ways:

- You click **Acquisition Method** from the **File > Print** menu.
- You review the parameters in the Method Editor.
- You can see method parameters associated with a data file in the Agilent MassHunter Workstation Qualitative Analysis software.

Acquisition Method reports include this information:

- Method name, path and description
- List of configured LC modules and TOF or Q-TOF
- Parameter values for each LC module and for the TOF or the Q-TOF



## 4 Data Acquisition

Interactive single sample setup 96

Worklist setup 98

Data acquisition for samples and worklists 114

Learn the concepts to help you understand the setup of single samples for interactive data acquisition and the setup of single samples and sequences of samples for automatic data acquisition.



## Interactive single sample setup

If you want to run just one sample at a time, you enter the information for that sample in the **Sample Run** window.

### Sample information

The sample information that the system records with the data file is the sample name, vial position and other information in the Sample Run window, such as Sample Type and Injection Volume.

Sample information is not part of the method. It is stored with the data file when the method currently loaded is run.

### Injection Volume

You can specify an injection volume for the sample in this box. You select the value **As Method** if you want to use the injection volume specified in the method.

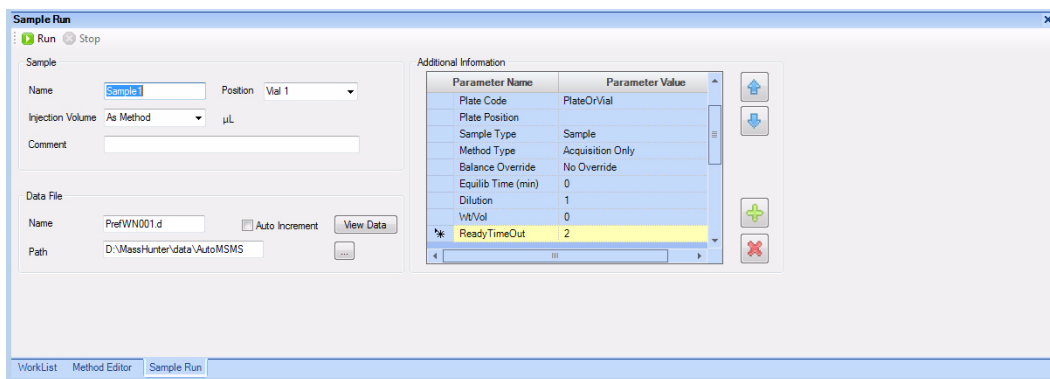

Figure 44 Sample Run window



## Data File information

The default folder for TOF/Q-TOF data is **D:\MassHunter\Data**.

**Auto Increment** If you want to use the same file name and have the system automatically change the number at the end of the file name, you turn auto-increment on. Then, you type a file name that ends in the number 001, and the system makes sure that a new file is created every time you re-run that sample.

### Other folders

You can save your data to any folder on the system. You must use the browse button to select a different folder. To open any data file saved to a different folder than **D:\MassHunter\Data**, you must browse to the different folder.

## Some of the Additional Information parameters

### Sample Type

You specify one of the following types for a single sample run: **Sample, Calibration, QC, Blank, DoubleBlank, Matrix, MatrixDup, MatrixBlank, ConCal, TuneCheck, and ResponseCheck**.

### Method Type

**Acquisition Only, DA Only, or Both Acquisition and DA**.

### Run Types

This value is not shown by default. You can add it by clicking the + button and adding it using the Add Parameters dialog box.

**Standard Start** for LC runs

**Manual Run** for infusion runs with a syringe pump

**External Start** for AP-MALDI

**LC Only Run** for when you do not acquire MS data

## Worklist setup

Agilent developed worklists for the primary purpose of running many samples automatically and then reporting on the compounds found in the samples.

The worklist lets you enter sequences of samples—both single and multiple samples—to be run automatically in the order of their listing.

The worklist operates as a spreadsheet much like Excel. You can copy, paste, and fill in columns as you would in Excel.

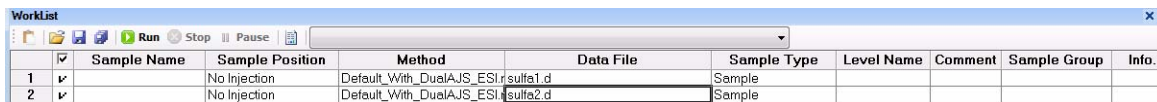

	<input checked="" type="checkbox"/>	Sample Name	Sample Position	Method	Data File	Sample Type	Level Name	Comment	Sample Group	Info.
1	<input checked="" type="checkbox"/>		No Injection	Default_With_DualAJS_ESI	sulf1.d	Sample				
2	<input checked="" type="checkbox"/>		No Injection	Default_With_DualAJS_ESI	sulf2.d	Sample				

Figure 45 Example worklist

**Selected sample execution**

Each line in the worklist table has a check box that allows you to mark that line for processing or not. This can be useful if you need to restart a worklist after some lines have already been run.

## Worklist menus

You find all the tasks to create a worklist in the worklist menus.

- Add a single sample one at a time or add multiple single samples all at once
- Add scripts before or after the worklist or between samples in a worklist
- Add or show more sample information columns
- Add, insert or delete rows and columns
- Set up to print a worklist report or track a worklist run

Each menu has different commands available. Some commands are only available in certain situations. For example, in the column shortcut menu, you can only use the Insert Column (s) command if you select a column that has been added using the Add Column(s) menu.

Right-click upper left-hand corner of worklist to view worklist menu.

Click Worklist to view top worklist menu.

Right-click cell to view cell menu.

Right-click column header to view column menu.

Select row and right-click row to view row menu.

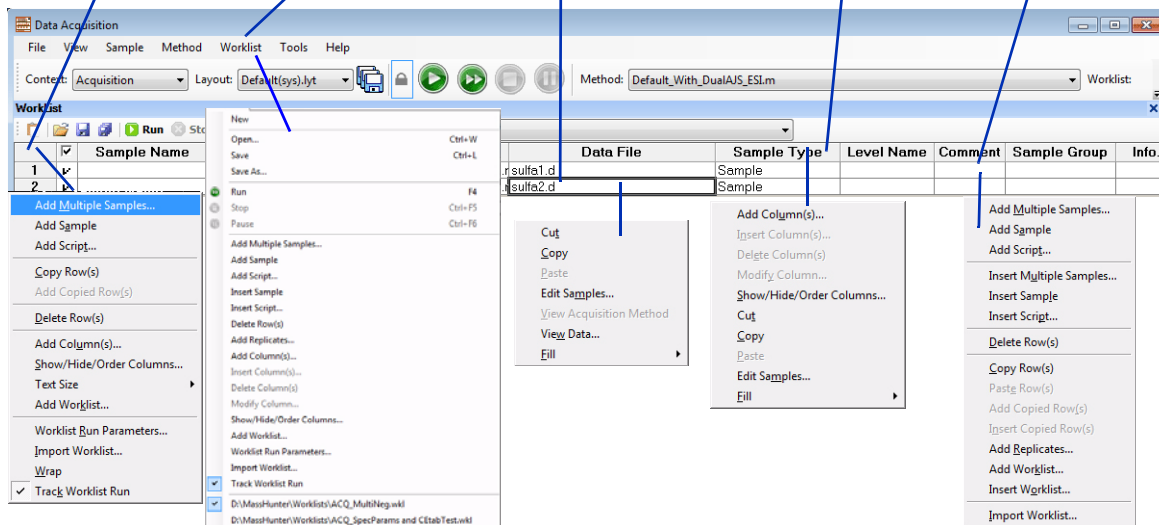

Figure 46 Worklist menus

## Sample entry

### One-at-a-time entry

You may want to do this to equilibrate the system before running a worklist.

### Multiple sample entry

If you want to add several single samples to the worklist at one time, you use the menu selection to add multiple samples. You can add different samples or one sample injected several times.

#### Sample information

When you add multiple samples, you can specify the data folder, method names and injection volume.

The screenshot shows the 'Add Multiple Samples' dialog box with the following details:

- Sample Information** (selected tab):
  - Sample:** Name: Sample, Append Counter:
  - Suffix Counter:** Number of digits: 1, Start Value: 3, Step: 1
  - Data File:** Name: WorklistData, Append Counter: 
    - Suffix Counter:** Number of digits: 1, Start Value: 3, Step: 1
    - Path:** D:\MassHunter\data
  - Method:** Name: ACQ\_AutoCEFixed.m, Path: D:\MassHunter\methods
  - Override DA Method:** Name: <None>, Path: D:\MassHunter\methods
  - Injection:** Injection Volume: As Method
- Buttons:** OK, Cancel

Figure 47 Add Multiple Samples dialog box

**Sample position** You can select the sample positions without having to type in their values from the Sample Position tab on the Add Multiple Samples dialog box.

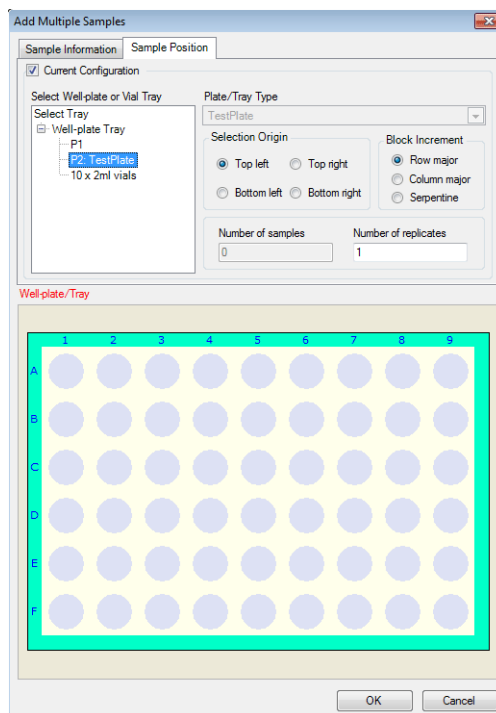

**Figure 48** Sample Position tab of the Add Multiple Samples dialog box

### Sample methods

You can create a .m method containing either acquisition parameters, data analysis parameters or both. See the *Quick Start Guide* or the online Help for instructions for creating the method.

If you specify a method with both acquisition and data analysis parameters in the worklist, you select which parts to run in the Worklist Run Parameters dialog box for a worklist and in the Sample Run window for a single sample run.

## Script entry

Scripts are special programs, that execute automatically. Agilent includes scripts with the Agilent MassHunter Workstation Software, and you can write your own scripts.

You can enter scripts to be run at the following times:

- Before or after samples as part of the method  
The sample method can include pre- and post-analysis scripts. (See Chapter 3, Acquisition Methods)
- Before or after samples in the worklist or batch (insert or add scripts, respectively)
- Before or after a worklist and after data acquisition (Figure 53 on page 109)

Scripts provided by Agilent should not be modified since these files may be overwritten when upgrading the Agilent software.

For detailed instructions on how to enter scripts, see the online Help. For instructions on how to create scripts, see your Agilent application engineer.

Agilent includes scripts with the software to help you automatically, instead of manually, execute processes such as column conditioning and valve shutoff. See Table 8 on page 92 for a list of possible scripts.

## Entry of additional sample information (show, add columns)

The default worklist contains only eight columns for sample information.

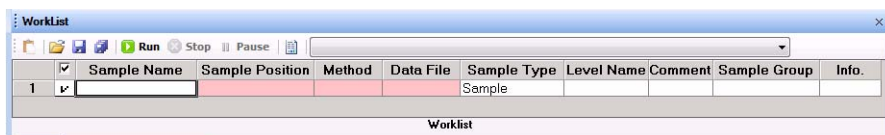

**Figure 49** Default worklist columns

*You can access these capabilities through the worklist menu.*

You can add more columns in one of two ways:

- Show or hide columns that contain sample information already available in the worklist
- Add columns for new sample information

### Show/Hide/Order sample information

*Note that hiding a column does not delete the column. To delete the column, you must first show the column in the worklist or batch.*

With this dialog box you can hide any of the original default columns and show others. You can also change the order of the columns. The marked columns are shown in the worklist in the order they appear in this dialog box.

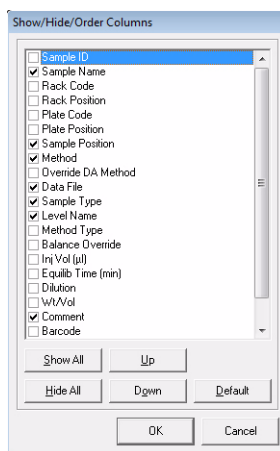
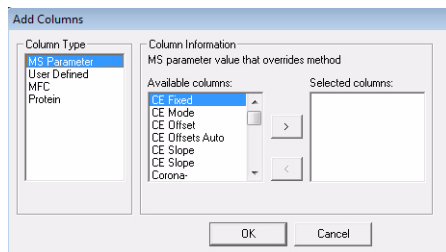

**Figure 50** Show/Hide/Order Columns dialog box

### Add sample information columns

When you add columns, you can enter sample information and values for compounds, masses and acquisition parameters. You can also enter your own sample information, including empirical formulas. You can add a column for the Molecular Formula which can be used in the Qualitative Analysis program. The Column Type **MFC** is only available if the Qualitative Analysis program is installed on the same computer. The Column Type **Protein** is only available if the MassHunter BioConfirm program is installed.

*When you add a column, it appears in the Show/Hide/Order Column dialog box.*



**Figure 51** Add Columns dialog box

## Worklist import

You can populate a worklist with sample information from other files in multiple ways:

- Use the Study Manager program which automatically creates a worklist when you submit a study.
- Copy individual columns one at a time from an Excel spreadsheet (or a csv file imported into Excel) and paste (or fill) them into the TOF or Q-TOF worklist under the correct header

You do this when you need to transfer information infrequently or the information is different for each transfer.

- Import a csv file directly

You do this when you need to use the same parameters in a worklist frequently.

*You cannot import a partial list of the samples within the csv file.*



## CSV file mapping

You use the **Map File Generator** program to modify a map file. You start this program by clicking the Map File Generator icon in the **Agilent MassHunter Workstation > Acq Tools** folder. See the online Help for more information on this program.

*You can import the csv file to add or insert samples whether the worklist is running or not. You can also import the file in an offline session.*

Your sample csv file contains a table of samples and attribute information for each sample. The information in this file may not correspond to the information needed in a TOF or Q-TOF worklist in several ways.

- Some of the information may not be relevant.
- Some information may be missing.
- Column names of the sample attributes may not be the same as those used by the Agilent MassHunter Workstation Data Acquisition software.

*You cannot import scripts into a worklist. You must add them directly.*

You must first edit the sample csv file to put it into a form that maps to TOF or Q-TOF sample data. You can specify these changes when you map to the TOF or Q-TOF data:

- Change the column header names
- Add new columns in the worklist
- Change data values

You can include a mapping section in front of the sample information in the sample csv file or in a separate configuration csv file. You use a configuration csv file when all the sample information values are the same from import to import. You also include the mapping section in the sample csv file when new groups of samples with different dynamic mapping of columns, such as amount of compounds analyzed, are added for import.

## Mapping for static worklist columns

Some worklist boxes are static and invariant, such as Sample Name and Sample Position. These come under the heading, Static Mapping, in the mapping section of the csv file.

### Mapping for dynamic worklist columns

Some columns in a worklist are dynamic and change from analysis to analysis. The mapping capability in the csv file lets you specify additional columns to be added to the worklist. The name of the added worklist column should use the same name as the csv column specified. You then specify the column type in the worklist, such as Compound, Mass, MS Parameter, User Defined or Custom Parameter. These new columns to be added to the worklist come under the heading, Dynamic Mapping, in the mapping section of the csv file.

**Data Value mapping** Data values for some columns, such as sample type, are limited to a drop-down list in the worklist and do not match the same names as are in the csv file. Data value mapping is preceded by the key words [Data Value Mapping]

### Example mapping section

You want to import samples into a TOF or Q-TOF worklist, but the column headers in the CSV import file (Excel spreadsheet) are different from the worklist column headers. For example, “Sample” is used instead of “Sample Name”, as shown below:

**Table 9** Original sample table

Sample	Acq Method	MyData	DA	SampPos	Sample Type	Internal Std A
AAA	method1	qwwwq	method1	1	Standard	1
BBB	method2	bbb	method1	2	Sample	1
CCC	method3	ccc	method1	3	QualControl	1

One column header, “InternalStdA”, must be added as a new column to the worklist. You can also add columns that do not exist in the csv file, such as “Caffeine” in the section below. Some data values are also different (e.g., Sample Type values).

[Table 10](#) is the mapping section for the spreadsheet in [Table 9](#). This is the spreadsheet version of the mapping that lets the worklist import program recognize columns of imported data.

**Table 10** Mapping section for csv file

[Static Mapping]

Acq Method	Acquisition Method
MyData	DataFile Name
DA	DataAnalysis Method
SampPos	Sample Position
Sample	Sample Name

[Dynamic Mapping]

(//Added column)

InternalStdA	Compound	1
Caffeine	Compound	

[Data Value Mapping]

Sample	Unknown
QualControl	QC

## Report setup

After you run the worklist, you can send a worklist report to one or more of these locations: **Screen, Printer, Excel File** or **PDF File**. You specify the report destination and the file path in the Worklist Report Options dialog box.

You can also specify to print all of the columns that are part of the table or to print only the visible columns, and you can select a different Worklist Report template. You can modify the worklist report template if you know how to modify an RDL report.

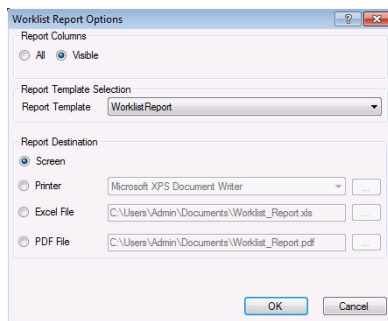

**Figure 52** Worklist Report Options dialog box

## Run setup

Before you run a worklist you select parameters for the entire worklist.

- Start run types and the part of the method to run
- Paths for the acquisition method, data analysis method and data file
- Whether or not to combine export output when also running a Qualitative Analysis method
- Scripts to run before or after the worklist
- Free disk threshold

The free disk threshold is the amount of disk space in gigabytes that must be available before the worklist starts.

Worklist Run Parameters

Page 1 Page 2

Operator Information

Operator name:

Run Information

Run Type:  Execution for Acquisition-DA:

Part of method to run:   Stop worklist on DA error

Method Paths

Method:  ...

Override DA:  ...

Data File

Path:  ...

Scripts

Pre-worklist ...

Post-worklist ...

Acquisition clean-up ...

Disk Information

Free Disk Threshold:  (Gbytes) Available Diskspace: 766.49 (Gbytes)

Run Settings

Overlapped Injection Wait Time for Ready:  (min)

Clear sample selection after run

OK Cancel

**Figure 53** Worklist Run Parameters dialog box

### **Overlapped Data Analysis with Acquisition**

You can choose to start the next data acquisition run when the data analysis is complete, or for higher throughput of samples, while data analysis of the previous sample is still running.

This option is selected in the Worklist Run Parameters dialog box, in the **Execution for Acquisition-DA** list box. To overlap data analysis with acquisition, select **Asynchronous**. To cause data acquisition to wait until data analysis is complete, select **Synchronous**.

### **Overlapped Injection**

You can load a sample into the sample loop during a run that is still completing. This option allows you to save time that is required to load the sample before the run.

To select this option, mark the **Overlapped Injection** check box in the Worklist Run Parameters. You also have to select this option in the individual methods being used in the worklist.

## **Estimate of worklist file size**

Depending on your estimate of the file size of the worklist, you may have to change the default value of the Free Disk Threshold.

You can run a typical worklist sample to estimate the worklist file size. Then, you observe the file size in Windows Explorer, and multiply the observed file size by the number of samples in the worklist.

The data file for profile data is compressed by a factor of 3 - 20, depending on the complexity of the mass spectra acquired. This new feature greatly reduces the data storage needed for profile data.

The Instrument Mode selected for the Accurate-Mass TOF and Accurate-Mass Q-TOF also affects the size of the data file. The Agilent TOF and Q-TOF instruments now will acquire 2 times as

much data when operated in the 2 GHz mode (extended dynamic range or extended mass range) or 4 times as much data when operated in the 4 GHz mode (high resolution).

### Method parameters that control file size

LC data is usually a small fraction of TOF or Q-TOF data. The size of the acquired data file depends on these TOF or Q-TOF method parameters:

- Data file storage type—Profile, Centroid, Both or None

**Profile** stores raw data as abundance values for evenly spaced ion flight time. **Centroid** stores only the assigned peaks but not the raw data. **Both** stores both Profile data and Centroid data. **None** stores no data but does store spectrum metadata and method parameters.

If you want to analyze your data in Qualitative Analysis using either the Large Molecular Feature Extractor (LMFE) algorithm or the Deconvolute (MS): Maximum Entropy algorithm, you acquire in either Profile or Both modes. Profile data is required for both of these algorithms.

- Total run time
- Setting of time segments
- Number of experiments that are defined

### Approximate file size for stored Profile data

The file size per spectrum depends on three variables.

- Mass range
- Spectrum metadata
- Compression factor - the data file is compressed by a factor of 2 to 20, depending on the complexity of the mass spectra acquired

**Mass range** You can reduce data file size by reducing the mass range of interest. Profile data are stored as abundance for each flight time. If you restrict the mass range, the number of data points in the spectrum depends on the mass calibration curve. The table below shows the number of possible data points for a

## 4 Data Acquisition

### Estimate of worklist file size

*Note that low masses require more data points than high masses because of the non-linear nature of the time to mass conversion.*

given mass range using a typical mass calibration curve. The Agilent 6540 UHD Accurate-Mass Q-TOF has approximately 25% more data points.

**Table 11** Number of data points pre spectrum for given mass ranges

Mass range (Daltons)	Number of data points (1 GHz)	Number of data points (2 GHz)	Number of data points (4 GHz)
50 to 750	50,000	100,000	200,000
50 to 1000	60,000	120,000	240,000
50 to 3000	100,000	200,000	400,000
250 to 1000	30,000	60,000	120,000
500 to 3000	60,000	120,000	240,000
250 to 3000	70,000	140,000	280,000

Each data point stored requires 12 bytes of storage. A mass range of 250 to 3000 requires 840,000 bytes per spectrum at 1 GHz acquisition rate. If the scans/sec. equal 1, then the data storage required for one minute worth of spectra before compression is 50,400,000 bytes or about 48 MB. Then, this data is compressed which means the actual data storage needed is between 2.4 MB and 16 MB (with a compression ratio between 3 and 20).

If the run time on a run with one time segment is 5 minutes, then one run requires between 12 MB and 80 MB of disk space. A worklist with 10 samples using the same mass range requires between 120 and 800 MB of disk space. If the scan rate is set to 20 scans per second, the data file could require a large amount of disk space.

**Spectrum metadata** In addition to data points, information on the spectrum, such as the instrument actuals and set points, used during acquisition is stored with each spectrum. This information takes 2884 bytes per spectrum or about 8.2 MB for the worklist described above.



Storage of method parameters for each run also affects file size but to a lesser degree than the file size of the spectrum. They take up about 10,000 bytes before sample injection starts. For a 10-sample worklist, they take up less than 0.1 MB.

### **Approximate file size for Centroid data**

Data is not stored as the abundance at evenly spaced ion flight times. Rather, peak centroids are computed first. Each data point is stored as a pair of values of mass and abundance. The data storage required is 12 bytes per detected peak in the spectrum. The number of peaks detected is dependent on the number of compound peaks in the spectrum as well as the noise in the background and the threshold set.

If the mass range is set as 250 to 3000 and the threshold is appropriate, about 3000 to 5000 peaks are detected in one spectrum. If the scans/sec. is 1, the run time 5 minutes, and ten samples are in the worklist, then the disk space needed for these samples is between 102 and 172.5 MB.

If you have a 2 GHz instrument, the disk space needed for these samples is between 204 and 345 MB. If you have a 4 GHz instrument, the disk space needed for these sample is between 408 and 690 MB.

Spectrum metadata and method parameters are also stored with centroid data and comprise a greater percent of the file size than with Profile data.

# Data acquisition for samples and worklists

## What you can monitor during a run

### Tracking sample runs

The worklist shortcut menus contain an option called “Track Worklist Run” that you can turn off or on. The default position is on. With Track Worklist Run on, you can see what sample is running at any time during the worklist run.

When you start a worklist run, the first sample row turns dark blue, indicating that the sample in this row is running and data is being acquired. When the data acquisition finishes, the first sample row turns light blue to indicate that Data Analysis is running.

If you have set **Execution for Acquisition-DA** to **Asynchronous**, you will see both a dark blue and a light blue line to indicate which lines are acquiring data and analyzing data.

### Monitoring the Chromatogram Plot and Spectrum Plot windows

You can also monitor the TIC or EIC chromatograms, LC parameters and mass spectra for each sample during the worklist run. You can print a plot of the real-time data by clicking the **File > Print > Real-time Plot** command.

*For more information on real-time plots, see “Real-time displays” on page 63.*

## What you can do during a run

### Locked Mode

You can turn Locked Mode on or off using the toolbar icons in the main toolbar. If Locked Mode is turned on, you cannot edit a worklist or method while the data is being acquired. Also, the data file is protected, so you cannot overwrite the data file if you run this method or worklist again. If Locked Mode is turned off, then you can edit the worklist during a run.

### Editing current worklist during run

You can edit any sample row or batch row during a run as long as the sample is located below or in the second row after the running sample row. If the last selected row is executing, then all rows are locked.

When you switch to a row to edit the sample, the “Track Worklist Run” option automatically turns off. To see the sample row running after your edit, you select this tracking option again. The screen then automatically switches to that part of the worklist with the sample that is running.

## **4 Data Acquisition**

What you can do during a run



[www.agilent.com](http://www.agilent.com)

## In This Book

The *Concepts Guide* presents “The Big Picture” behind the Agilent 6200 Series TOF and 6500 Series Q-TOF LC/MS system to help you to understand how to use the TOF and Q-TOF LC/MS system components.

This guide includes concepts for:

- Inner workings of the TOF and Q-TOF MS
- Instrument Preparation
- Methods with Acquisition Parameters
- Data Acquisition

© Agilent Technologies, Inc. 2011

Printed in USA  
Revision A, December 2011



G3335-90116



**Agilent Technologies**