

905 Titrande



Manual
8.905.8003EN



Metrohm AG

CH-9100 Herisau

Switzerland

Phone +41 71 353 85 85

Fax +41 71 353 89 01

info@metrohm.com

www.metrohm.com

905 Titrande

Manual

Teachware
Metrohm AG
CH-9100 Herisau
teachware@metrohm.com

This documentation is protected by copyright. All rights reserved.

Although all the information given in this documentation has been checked with great care, errors cannot be entirely excluded. Should you notice any mistakes please send us your comments using the address given above.

Documentation in additional languages can be found on
<http://documents.metrohm.com>.

Table of contents

1	Introduction	1
1.1	The Titrando system	1
1.2	Instrument description	2
1.3	Titration modes – Measuring modes – Dosing commands	3
1.4	About the documentation	5
1.4.1	Symbols and conventions	5
1.5	Safety instructions	6
1.5.1	General notes on safety	6
1.5.2	Electrical safety	6
1.5.3	Working with liquids	7
1.5.4	Flammable solvents and chemicals	7
1.5.5	Recycling and disposal	7
2	Overview of the instrument	8
3	Installation	10
3.1	Setting up the instrument	10
3.1.1	Packaging	10
3.1.2	Checks	10
3.1.3	Location	10
3.2	Connecting a controller	10
3.2.1	Operation	10
3.3	Connecting MSB devices	14
3.3.1	Connecting a dosing device	15
3.3.2	Connecting a stirrer or titration stand	16
3.3.3	Connecting a Remote Box	17
3.4	Connecting USB devices	18
3.4.1	General	18
3.4.2	Connecting a USB hub	19
3.4.3	Connecting a printer	19
3.4.4	Connecting a balance	20
3.4.5	Connecting a PC keyboard (only for operation with Touch Control)	21
3.4.6	Connecting a barcode reader	22
3.5	Connecting sensors	23
3.5.1	Connecting a pH, metal or ion-selective electrode	23
3.5.2	Connecting a reference electrode	24
3.5.3	Connecting a polarizable electrode	24
3.5.4	Connecting a temperature sensor or an electrode with integrated temperature sensor	25



3.5.5	Connecting an iConnect	25
3.5.6	Differential potentiometry	27
4	Setting up the titration vessel	28
4.1	General	28
5	Operation and maintenance	29
5.1	General notes	29
5.1.1	Care	29
5.1.2	Maintenance by Metrohm Service	29
5.2	Quality Management and qualification with Metrohm	30
6	Troubleshooting	31
6.1	General	31
6.2	SET titration	31
6.2.1	31
7	Appendix	33
7.1	Remote interface	33
7.1.1	Pin assignment of the remote interface	33
8	Technical specifications	37
8.1	Measuring interface	37
8.1.1	Potentiometry	37
8.1.2	Temperature	37
8.1.3	Polarizer	38
8.2	Power connection	39
8.3	Safety specifications	39
8.4	Electromagnetic compatibility (EMC)	39
8.5	Ambient temperature	40
8.6	Reference conditions	40
8.7	Dimensions	40
8.8	Interfaces	40
9	Warranty (guarantee)	42
10	Accessories	44
10.1	Scope of delivery	44
10.1.1	2.905.0010	44
10.1.2	2.905.0020	45
10.2	Optional accessories	47
10.2.1	2.905.0010 and 2.905.0020	47



Index

54



Table of figures

Figure 1	The Titrand system	1
Figure 2	Front 905 Titrand	8
Figure 3	Rear 905 Titrand	9
Figure 4	Connecting the Touch Control	11
Figure 5	Connecting the computer	13
Figure 6	MSB connections	14
Figure 7	Connecting a dosing device	16
Figure 8	Connecting an MSB stirrer	17
Figure 9	Connecting the propeller stirrer to the titration stand	17
Figure 10	Connecting the Remote Box	18
Figure 11	Connecting a printer	20
Figure 12	Connecting a pH, metal or ion-selective electrode	23
Figure 13	Connecting a reference electrode	24
Figure 14	Connecting a polarizable electrode	24
Figure 15	Connecting a temperature sensor or an electrode with integrated temperature sensor	25
Figure 16	Connecting the iConnect	26
Figure 17	Connecting an electrode to the iConnect	26
Figure 18	Schematic configuration of magnetic stirrer, electrode and buret tip during a titration. a) stirring direction clockwise, b) stirring direction counterclockwise.	28
Figure 19	Connectors of the Remote Box	33
Figure 20	Pin assignment of remote socket and remote plug	33

1 Introduction

1.1 The Titrando system

The Titrando is the heart of the modular Titrando system. Operation is carried out either by Touch Control with a touch-sensitive screen ("stand-alone titrator") or by a computer with a corresponding software.

A Titrando system can contain numerous kinds of a variety of instruments. The following figure provides an overview of the peripheral devices you can connect to the 905 Titrando.

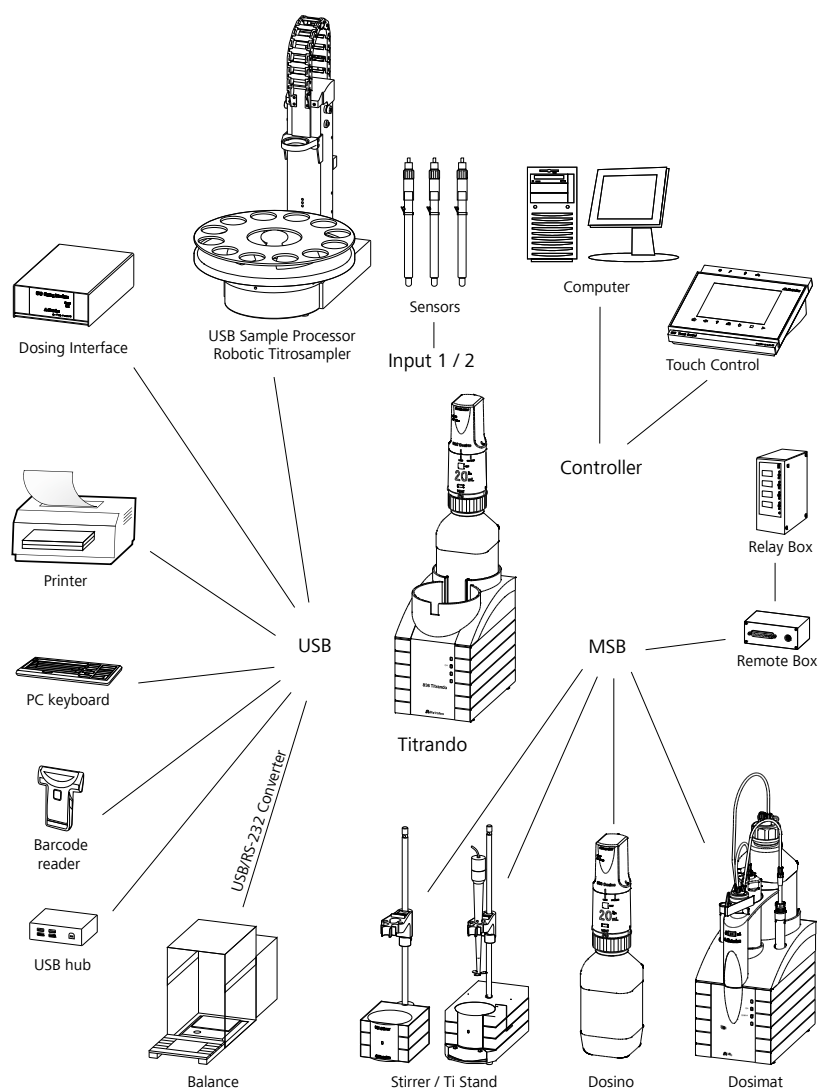

Figure 1 The Titrando system



Up to three control instruments (Titrande, Dosing Interface, USB Sample Processor, etc.) can be controlled via USB connection during operation with the 900 Touch Control.

You can request information on special applications in the "Application Bulletins" and "Application Notes", available free of charge through the responsible Metrohm representative. Various monographs on the subjects of titration techniques and electrodes are also available.

Updating the device software is described in the Help for the corresponding PC software.

1.2 Instrument description

The 905 Titrande has the following characteristics:

- **Operation**

Operation is carried out by means of a touch-sensitive Touch Control or with high-performance PC software.

- **MSB connectors**

Four MSB connectors (Metrohm Serial Bus) for connecting dosing devices (Dosimat with exchange unit or Dosino with dosing unit), stirrers, titration stands and Remote Boxes.

- **USB connectors**

Two USB connectors, through which devices such as printers, PC keyboards, barcode readers or additional control instruments (USB Sample Processor, Titrande, Dosing Interface, etc.) can be connected.

- **Measuring interface**

Depending on the model version, one or two measuring interface(s).

Each measuring interface has one measuring input each for:

- a potentiometric electrode (pH, metal or ion-selective electrode)
- a separate reference electrode
- a temperature sensor (Pt1000 or NTC)
- a polarizable electrode
- an iConnect (measuring interface for electrodes with integrated data chip, so-called iTrodes)

1.3 Titration modes – Measuring modes – Dosing commands

The 905 Titrande supports the following titration modes, measuring modes and dosing commands:

▪ DET

Dynamic equivalence point titration. The reagent addition is carried out in variable volume steps.

Measuring modes:

- **pH** (pH measurement)
- **U** (potentiometric voltage measurement)
- **Ipol** (voltametric measurement with selectable polarization current)
- **Upol** (amperometric measurement with selectable polarization voltage)

▪ MET

Monotonic equivalence point titration. The reagent addition is carried out in constant volume steps.

Measuring modes:

- **pH** (pH measurement)
- **U** (potentiometric voltage measurement)
- **Ipol** (voltametric measurement with selectable polarization current)
- **Upol** (amperometric measurement with selectable polarization voltage)

▪ SET

Endpoint titration at one or two specified endpoints.

Measuring modes:

- **pH** (pH measurement)
- **U** (potentiometric voltage measurement)
- **Ipol** (voltametric measurement with selectable polarization current)
- **Upol** (amperometric measurement with selectable polarization voltage)



- **MEAS**

The following measuring modes can be selected for measurements:

- **pH** (pH measurement)
- **U** (potentiometric voltage measurement)
- **Ipol** (voltametric measurement with selectable polarization current)
- **Upol** (amperometric measurement with selectable polarization voltage)
- **Conc** (concentration measurement with or without standard addition)
- **T** (temperature measurement)

- **STDADD**

The measuring modes for standard addition are listed separately only in *tiamo*TM. In Touch Control they are integrated in the measuring mode MEAS Conc.

The following measuring modes can be selected for measurements:

- **auto** (automatic addition of the standard addition solution by specifying a potential difference)
- **dos** (automatic addition of the standard addition solution by specifying the individual volume increments)
- **man** (manual addition of the standard addition solution)

- **CAL**

Electrode calibration.

Measuring mode:

- **pH** (calibration of pH electrodes)
- **Conc** (calibration of ion-selective electrodes)

- **ELT**

Electrode test for pH electrodes.

This mode is listed separately only in *tiamo*TM. In Touch Control, the electrode test is a component part of the CAL calibration mode.

- **Dosing commands**

The following commands for dosing can be selected:

- **PREP** (rinsing the cylinder and tubings of an exchange unit or dosing unit)
- **EMPTY** (emptying the cylinder and tubings of a dosing unit)
- **ADD** (dosing a specified volume)
- **LQH** (carrying out complex dosing tasks with a Dosino)

1.4 About the documentation







CAUTION

Please read through this documentation carefully before putting the instrument into operation. The documentation contains information and warnings which the user must follow in order to ensure safe operation of the instrument.

1.4.1 Symbols and conventions

The following symbols and formatting may appear in this documentation:

(5-12)	Cross-reference to figure legend The first number refers to the figure number, the second to the instrument part in the figure.
1	Instruction step Carry out these steps in the sequence shown.
Method	Dialog text, parameter in the software
File ▶ New	Menu or menu item
[Next]	Button or key
	WARNING This symbol draws attention to a possible life-threatening hazard or risk of injury.
	WARNING This symbol draws attention to a possible hazard due to electrical current.
	WARNING This symbol draws attention to a possible hazard due to heat or hot instrument parts.
	WARNING This symbol draws attention to a possible biological hazard.
	CAUTION This symbol draws attention to possible damage to instruments or instrument parts.

**NOTE**

This symbol highlights additional information and tips.

1.5 Safety instructions

1.5.1 General notes on safety

**WARNING**

This instrument may only be operated in accordance with the specifications in this documentation.

This instrument has left the factory in a flawless state in terms of technical safety. To maintain this state and ensure non-hazardous operation of the instrument, the following instructions must be observed carefully.

1.5.2 Electrical safety

The electrical safety when working with the instrument is ensured as part of the international standard IEC 61010.

**WARNING**

Only personnel qualified by Metrohm are authorized to carry out service work on electronic components.

**WARNING**

Never open the housing of the instrument. The instrument could be damaged by this. There is also a risk of serious injury if live components are touched.

There are no parts inside the housing which can be serviced or replaced by the user.

Mains voltage

**WARNING**

An incorrect mains voltage can damage the instrument.

Only operate this instrument with a mains voltage specified for it (see rear panel of the instrument).

Protection against electrostatic charges



WARNING

Electronic components are sensitive to electrostatic charges and can be destroyed by discharges.

Do not fail to pull the mains cable out of the mains connection socket before you set up or disconnect electrical plug connections at the rear of the instrument.

1.5.3 Working with liquids



CAUTION

Periodically check all system connections for leaks. Observe the relevant regulations in respect to working with flammable and/or toxic fluids and their disposal.

1.5.4 Flammable solvents and chemicals



WARNING

All relevant safety measures are to be observed when working with flammable solvents and chemicals.

- Set up the instrument in a well-ventilated location (e.g. fume cupboard).
- Keep all sources of flame far from the workplace.
- Clean up spilled liquids and solids immediately.
- Follow the safety instructions of the chemical manufacturer.

1.5.5 Recycling and disposal

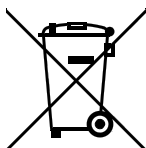

This product is covered by European Directive 2002/96/EC, WEEE – Waste from Electrical and Electronic Equipment.

The correct disposal of your old equipment will help to prevent negative effects on the environment and public health.

More details about the disposal of your old equipment can be obtained from your local authorities, from waste disposal companies or from your local dealer.

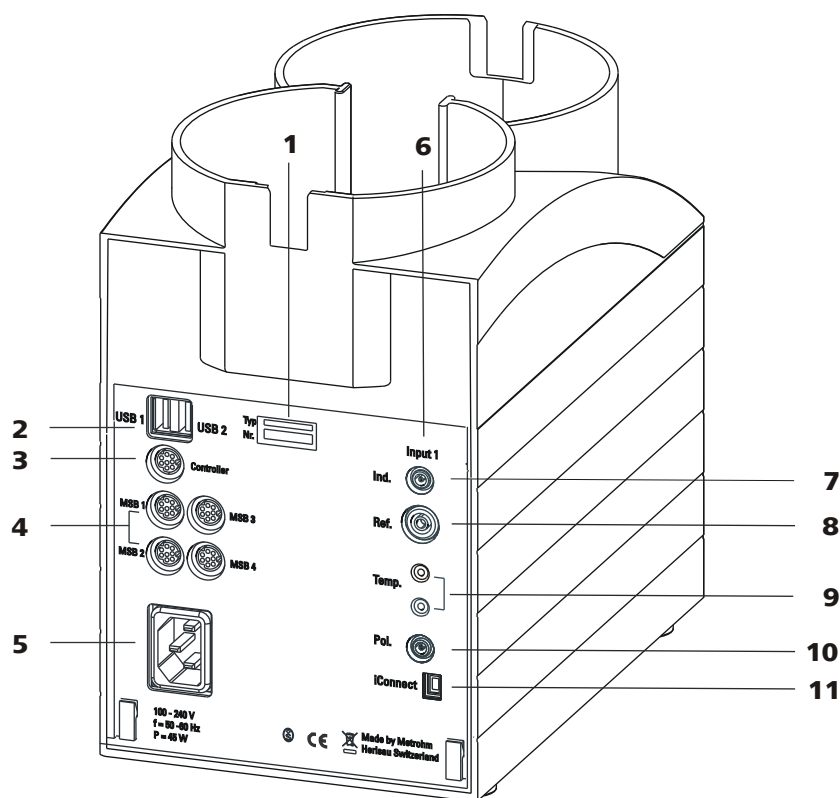

Figure 3 Rear 905 Titrand

<p>1 Type plate Contains specifications concerning supply voltage, instrument type and serial number.</p>	<p>2 USB connector (USB 1 and USB 2) USB ports (type A) for connecting printer, keyboard, barcode reader, additional Titrandos, USB Sample Processor, etc.</p>
<p>3 Connector (Controller) For connecting a Touch Control or a PC with installed PC software. Mini DIN, 9-pin.</p>	<p>4 MSB connector (MSB 1 to MSB 4) Metrohm Serial Bus. For connecting external dosing devices, stirrers or Remote Boxes. Mini DIN, 9-pin.</p>
<p>5 Power socket</p>	<p>6 Measuring interface 1 (Input 1)</p>
<p>7 Electrode connector (Ind.) For connecting pH, metal or ion-selective electrodes with integrated or separated reference electrode. Socket F.</p>	<p>8 Electrode connector (Ref.) For connecting reference electrodes, e.g. Ag/AgCl reference electrode. Socket B, 4 mm.</p>
<p>9 Temperature sensor connector (Temp.) For connecting temperature sensors (Pt1000 or NTC). Two B sockets, 2 mm.</p>	<p>10 Electrode connector (Pol.) For connecting polarizable electrodes, e.g. double Pt wire electrodes. Socket F.</p>
<p>11 Electrode connector (iConnect) For connecting electrodes with integrated data chip (iTrodes).</p>	



3 Installation

3.1 Setting up the instrument

3.1.1 Packaging

The instrument is supplied in highly protective special packaging together with the separately packed accessories. Keep this packaging, as only this ensures safe transportation of the instrument.

3.1.2 Checks

Immediately after receipt, check whether the shipment has arrived complete and without damage by comparing it with the delivery note.

3.1.3 Location

The instrument has been developed for operation indoors and may not be used in explosive environments.

Place the instrument in a location of the laboratory which is suitable for operation, free of vibrations, protected from corrosive atmosphere, and contamination by chemicals.

The instrument should be protected against excessive temperature fluctuations and direct sunlight.

3.2 Connecting a controller

3.2.1 Operation

Two different versions are available for operating the 905 Titrando:

- A Touch Control with touch-sensitive screen. It forms a "stand-alone instrument" together with the 905 Titrando.
- A computer enables operation of the 905 Titrando with the help of a PC software, e.g. *tiamo*.



CAUTION

Take care to ensure that the power supply cable is pulled out of the power socket before either setting up or disconnecting connections between the instruments.

3.2.1.1 Connecting a Touch Control



NOTE

The plug is protected against accidental disconnection of the cable by means of a pull-out protection feature. If you wish to pull out the plug, you will first need to pull back the outer plug sleeve marked with arrows.

Connect the Touch Control as follows:

- 1 ■ Insert the plug of the Touch Control connection cable into the **Controller** socket.

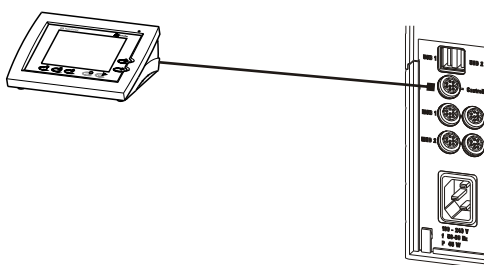

Figure 4 Connecting the Touch Control

- 2 ■ Connect the MSB devices (see Chapter 3.3, page 14).
 - Connect the USB devices (see Chapter 3.4, page 18).
- 3 ■ Connect the Titrando to the power supply.
- 4 ■ Switch on the Touch Control.

The Touch Control power supply is supplied through the Titrando. Automatic system tests are performed on both instruments at the time of activation. The **On** LED on the front of the Titrando lights up when the system test has been completed and the instrument is ready for operation.



CAUTION

The Touch Control must be shut down properly by deactivation with the power switch on the rear of the instrument before the power supply is interrupted. If this is not done, then there is a danger of data loss. Because of the fact that the power supply for the Touch Control is provided through the Titrande, you must never disconnect the Titrande from the power supply (e.g. by deactivating with a connector strip) before you have deactivated the Touch Control.

If you would prefer not to position the Touch Control directly next to the Titrande, then you can lengthen the connection with the 6.2151.010 cable. The maximum connection length permitted is 5 m.

3.2.1.2 Connecting a computer

The 905 Titrande requires a USB connection to a computer in order to be able to be controlled by a PC software. Using a 6.2151.000 controller cable, the instrument can be connected directly, either to a USB socket on a computer, to a connected USB hub or to a different Metrohm control device.

You need administrator rights for the installation of driver software and control software on your computer.

Cable connection and driver installation

A driver installation is required in order to ensure that the 905 Titrande is recognized by the PC software. To accomplish this, you must comply with the procedures specified. The following steps are necessary:

1 Installing the software

- Insert the PC software installation CD and carry out the installation program directions.
- Exit the program if you have started it after the installation.

2 Establishing the cable connections

- Connect all peripheral devices to the instrument, *see Chapter 3.3, page 14* and *see Chapter 3.4, page 18*.
- Connect the instrument to the power supply if you have not already done this.
The "On" LED on the 905 Titrande is not yet illuminated!
- Connect the instrument to a USB connector (Type A) of your computer (*see manual of your computer*). The 6.2151.000 cable is used for this purpose.

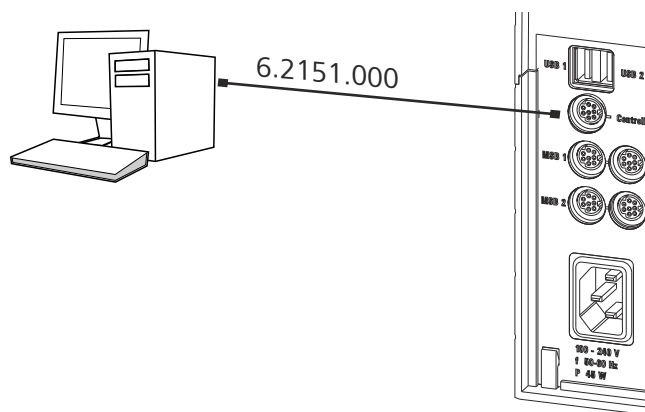

Figure 5 Connecting the computer

The instrument is recognized. Depending on the version of the Windows operating system used, the driver installation proceeds differently afterwards. Either the necessary driver software is installed automatically or an installation wizard is started.

3 Follow the instructions of the installation wizard.

The "On" LED on the 905 Titrande lights up when the driver installation has been completed and the instrument is ready for operation.

If problems should occur during installation, contact your company's IT support team.



NOTE

The plug on the instrument end of the 6.2151.000 controller cable is protected against accidental disconnection by means of a pull-out protection feature. If you wish to pull out the plug, you will first need to pull back the outer plug sleeve marked with arrows.

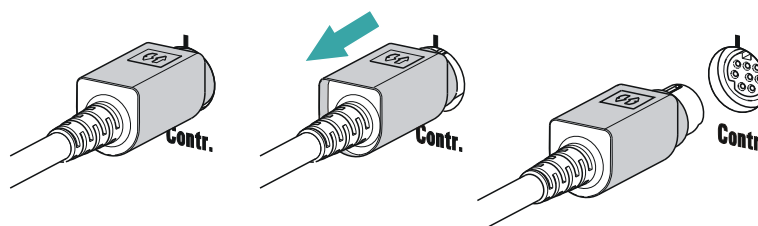

Registering and configuring the instrument in the PC software

The instrument must be registered in the configuration of your PC software. Once that has been done, you can then configure it according to your requirements. Proceed as follows:



1 Setting up the instrument

- Start the PC software.
The instrument is automatically recognized. The configuration dialog for the instrument is displayed.
- Make configuration settings for the instrument and its connectors.

More detailed information concerning the configuration of the instrument can be found in the documentation for the respective PC software.

3.3 Connecting MSB devices

In order to connect MSB devices, e.g. stirrers or dosing devices, Metrohm instruments are equipped with up to a maximum of four connectors on what is referred to as the *Metrohm Serial Bus* (MSB). Various kinds of peripheral devices can be connected in sequence (in series, as a "daisy chain") at a single MSB connector (8-pin Mini DIN socket) and controlled simultaneously by the respective control device. In addition to the connection cable, stirrers and the Remote Box are each equipped with their own MSB socket for this purpose.

The following figure provides an overview of the instruments that can be connected to an MSB socket, along with a number of different cabling variations.

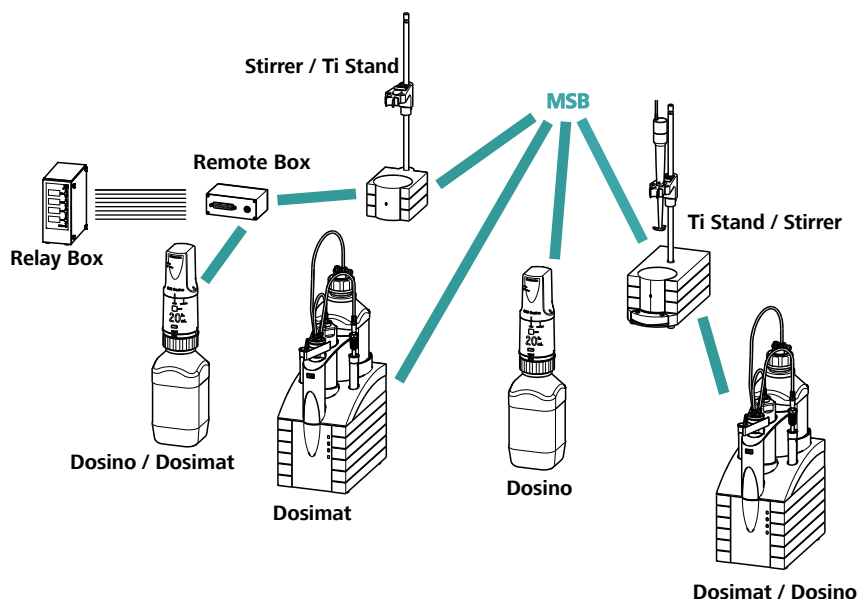

Figure 6 MSB connections

The control device determines which peripheral devices are supported.

**NOTE**

When connecting MSB devices together, the following must be observed:

- Only one device of the same type can be used at a single MSB connector at one time.
- Type 700 Dosino and 685 Dosimat dosing devices cannot be connected together with other MSB instruments on a shared connector. These dosing devices must be connected separately.

**CAUTION**

Exit the control software before you plug in MSB instruments. When it is switched on, the control device automatically recognizes which device is connected to which MSB connector. The operating unit or the control software enters the connected MSB devices into the system configuration (device manager).

MSB connections can be extended with the 6.2151.010 cable. The maximum connection length permitted is 15 m.

3.3.1 Connecting a dosing device

Four dosing devices can be connected to the instrument (**MSB 1 to MSB 4**).

The types of dosing devices that are supported are:

- 800 Dosino
- 700 Dosino
- 805 Dosimat
- 685 Dosimat

Proceed as follows:

1 Connecting a dosing device

- Exit the control software.
- Connect the connection cable of the dosing device to one of the sockets marked with **MSB** on the rear of the control device.
- Start the control software.

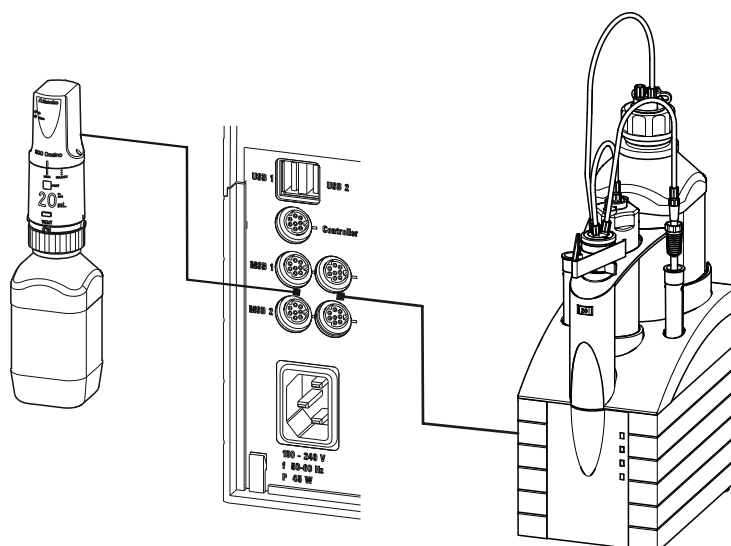

Figure 7 Connecting a dosing device

3.3.2 Connecting a stirrer or titration stand

You can use the following instruments:

- With built-in magnetic stirrer (stirring "from below"):
 - 801 Stirrer
 - 803 Ti Stand
- Without built-in magnetic stirrer (stirring "from above"):
 - 804 Ti Stand with propeller stirrer 802 Stirrer

Connect a stirrer or a titration stand as follows:

1 Connecting the stirrer or titration stand

- Exit the control software.
- Connect the connection cable of the magnetic stirrer or of the titration stand to one of the sockets marked with **MSB** on the rear of the control device.
- 804 Ti Stand only: Connect the propeller stirrer to the stirrer connector (socket with stirrer symbol) of the titration stand.
- Start the control software.

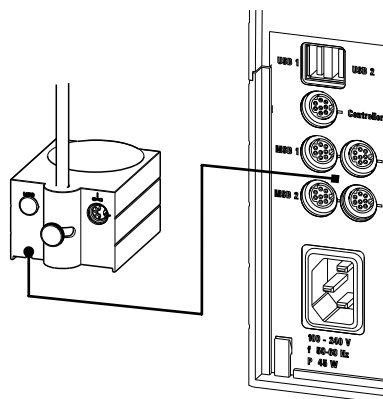

Figure 8 Connecting an MSB stirrer

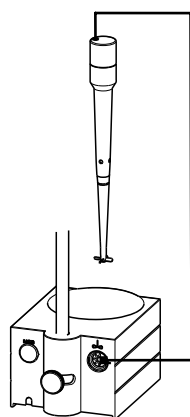

Figure 9 Connecting the propeller stirrer to the titration stand

3.3.3 Connecting a Remote Box

Instruments that are controlled via remote lines and/or that send control signals via remote lines can be connected via the 6.2148.010 Remote Box. In addition to Metrohm, other instrument manufacturers also use similar connectors that make it possible to connect different instruments together. These interfaces are also frequently given the designations "TTL Logic", "I/O Control" or "Relay Control" and generally have a signal level of 5 volts.

Control signals are understood to be electrical line statuses or electrical pulses (> 200 ms) which display the operating status of an instrument or which trigger or report an event. Sequences on a variety of instruments can thus be coordinated in a single complex automation system. No exchange of data is possible, however.

Proceed as follows:

1 Connecting the Remote Box

- Exit the control software.



- Connect the Remote Box connection cable to one of the sockets marked with **MSB** on the rear of the control device.
- Start the control software.

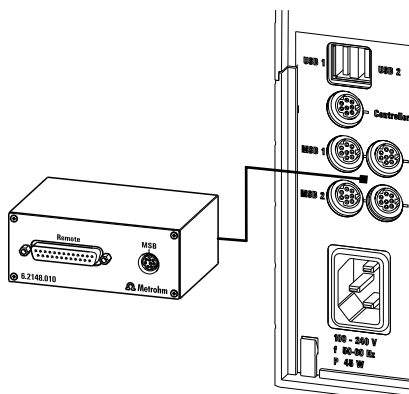

Figure 10 Connecting the Remote Box

You can, for example, connect an 849 Level Control (fill level monitoring in a canister) or a 731 Relay Box (switch box for 230/110 volt alternating current sockets and low-voltage direct current outlets). The Remote Box also has an MSB socket at which a further MSB device, e.g. a dosing device or a stirrer, can be connected.

You will find precise information concerning the pin assignment of the interface on the Remote Box in the appendix.

3.4 Connecting USB devices

3.4.1 General

The 905 Titrande has two USB connectors (type A sockets) for peripheral devices with USB interfaces. The Titrande functions as a USB hub (distributor) no matter how it is operated. If you wish to connect more than two devices to the USB, you can also use an additional, commercially available USB hub.



CAUTION

If you operate the 905 Titrande with the aid of the Touch Control, take care to ensure that the Touch Control is switched off when you set up or disconnect connections between the various instruments. If you use a PC software to control the 905 Titrande, you should exit the program before you set up or disconnect the USB connections.

3.4.2 Connecting a USB hub

If you wish to connect more than two devices to the USB connector of the 905 Titrande, you can also use an additional commercially available USB hub (distributor). If you operate the 905 Titrande with the help of the Touch Control, then you should use a USB hub with its own power supply.

Connect the USB hub as follows:

- 1** Switch off the Touch Control and/or exit the PC software.
- 2** With the aid of the 6.2151.020 cable, connect the USB connector of the 905 Titrande (type A) with the USB connector of the hub (type B, see manual for the hub).
- 3** Switch on the Touch Control.

The USB hub is recognized automatically.

3.4.3 Connecting a printer

Printers that are connected to the 905 Titrande with Touch Control must meet the following requirements:

- Printer languages: HP-PCL (PCL 3 to 5, PCL 3GUI), Canon BJL Commands or Epson ESC P/2
- Printer resolution: 300 dots/inch or 360 dots/inch (Epson)
- Paper size: A4 or Letter, single-sheet feed.

Connect the printer as follows:

- 1** Switch off the Touch Control.
- 2** With the aid of the 6.2151.020 cable, connect the USB connector of the 905 Titrande (type A) with the USB connector of the printer (type B, see manual for the printer).
- 3** Switch on the printer first, then the Touch Control.
- 4** Configure the printer in the device manager of the Touch Control (see Touch Control manual).

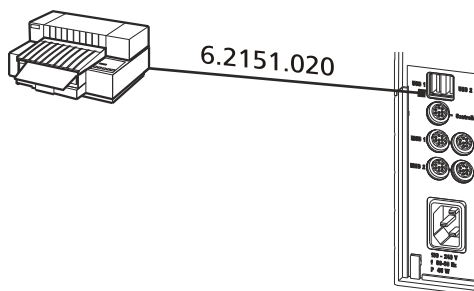

Figure 11 Connecting a printer

3.4.4 Connecting a balance

- Operation with a PC software:
 - Connect the balance directly to the serial connector (COM) of the computer. This is usually 9-pin and marked with the symbol **IOIOI**.
- Operation with Touch Control:
 - You will need the 6.2148.050 USB/RS-232 adapter to connect a balance.

The following table offers an overview of the balances that you can use together with the 905 Titrando and of which cable you will need for connection to the RS-232 interface:

Balance	Cable
AND ER, FR, FX with RS-232 interface (OP-03)	6.2125.020 + 6.2125.010
Mettler AB, AG, PR (LC-RS9)	In the scope of delivery for the balance
Mettler AM, PM, PE with interface option 016 or Mettler AJ, PJ with interface option 018	6.2146.020 + 6.2125.010 Also from Mettler: ME 47473 adapter and either ME 42500 hand switch or ME 46278 foot switch
Mettler AT	6.2146.020 + 6.2125.010 Also from Mettler: ME 42500 hand switch or ME 46278 foot switch
Mettler AX, MX, UMX, PG, AB-S, PB-S, XP, XS	6.2134.120

Balance	Cable
Mettler AE with interface option 011 or 012	6.2125.020 + 6.2125.010 Also from Mettler: ME 42500 hand switch or ME 46278 foot switch
Ohaus Voyager, Explorer, Analytical Plus	Cable AS017-09 from Ohaus
Precisa balances with RS-232-C interface	6.2125.080 + 6.2125.010
Sartorius MP8, MC, LA, Genius, Cubis	6.2134.060
Shimadzu BX, BW	6.2125.080 + 6.2125.010

Operation with Touch Control

Connect the balance as follows:

- 1 Plug in the USB plug of the USB/RS-232 adapter at the USB connector of the 905 Titrando.
- 2 Connect the RS-232 interface of the USB/RS-232 adapter with the RS-232 interface of the balance (see table for cable).
- 3 Switch on the Touch Control.
- 4 Switch on the balance.
- 5 Activate the RS-232 interface of the balance if necessary.
- 6 Configure the RS-232 interface of the USB/RS-232 adapter in the device manager of the Touch Control (see Touch Control manual).

3.4.5 Connecting a PC keyboard (only for operation with Touch Control)

The PC keyboard is used as an aid for text and numerical input.

Connect the PC keyboard as follows:

- 1 Insert the USB plug of the keyboard into one of the USB sockets of the 905 Titrando.



- 2 Switch on the Touch Control.

The keyboard is recognized automatically and entered in the device manager.

- 3 Configure the keyboard in the device manager of the Touch Control (see Touch Control manual).

3.4.6 Connecting a barcode reader

The barcode reader is used as an aid for text and numerical input. You can connect a barcode reader with USB interface.

Operation with Touch Control

Connect the barcode reader as follows:

- 1 Insert the USB plug of the barcode reader into one of the USB sockets of the 905 Titrande.
- 2 Switch on the Touch Control.
The barcode reader is recognized automatically and entered in the device manager.
- 3 Configure the barcode reader in the device manager of the Touch Control (see Touch Control manual).

Settings on the barcode reader:

Program the barcode reader as follows (see also the manual for the barcode reader):

- 1 Switch the barcode reader to programming mode.
- 2 Specify the desired layout for the keyboard (USA, Germany, France, Spain, German-speaking Switzerland).
This setting must match the setting in the device manager (see the Touch Control manual).
- 3 Make sure that the barcode reader is set in such a way that Ctrl characters (ASCII 00 to 31) can be sent.

- 4 Program the barcode reader in such a way that the ASCII character 02 (STX or Ctrl B) is sent as the first character. This first character is normally referred to as the "Preamble" or "Prefix Code".
- 5 Program the barcode reader in such a way that the ASCII character 04 (EOT or Ctrl D) is sent as the last character. This last character is normally referred to as the "Postamble", "Record Suffix" or "Postfix Code".
- 6 Exit the programming mode.

3.5 Connecting sensors

The measuring interface contains the following measuring inputs:

- **Ind.** for a potentiometric electrode (pH, metal or ion-selective electrode)
- **Ref.** for a separate reference electrode
- **Temp.** for a temperature sensor (Pt1000 or NTC)
- **Pol.** for a polarizable electrode
- **iConnect** for an iConnect (measuring interface for electrodes with integrated data chip, so-called iTrodes)

3.5.1 Connecting a pH, metal or ion-selective electrode

Connect the pH, metal or ion-selective electrode as follows:

- 1 Plug the electrode plug into the **Ind.** socket of the 905 Titrando.

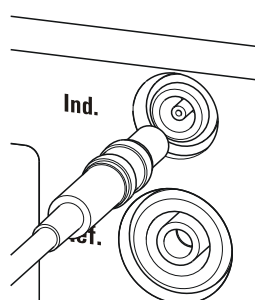

Figure 12 Connecting a pH, metal or ion-selective electrode

**NOTE**

The electrode cable is protected against accidental disconnection of the cable by means of a pull-out protection. If you wish to pull out the plug again, you will first need to pull back the outer plug sleeve.

3.5.2 Connecting a reference electrode

Connect the reference electrode as follows:

- 1 Plug the electrode plug into the **Ref.** socket of the 905 Titrande.

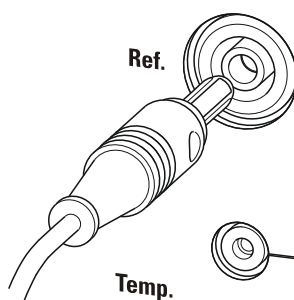

Figure 13 Connecting a reference electrode

3.5.3 Connecting a polarizable electrode

Connect the polarizable electrode as follows:

- 1 Plug the electrode plug into the **Pol.** socket of the 905 Titrande.

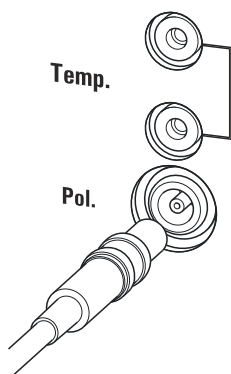

Figure 14 Connecting a polarizable electrode

**NOTE**

The electrode cable is protected against accidental disconnection of the cable by means of a pull-out protection. If you wish to pull out the plug again, you will first need to pull back the outer plug sleeve.

3.5.4 Connecting a temperature sensor or an electrode with integrated temperature sensor

A temperature sensor of the Pt1000 or NTC type can be connected to the **Temp.** connector.

Connect the temperature sensor or the electrode with integrated temperature sensor as follows:

- 1 Insert the plugs of the temperature sensor into the **Temp.** sockets of the Titrando.

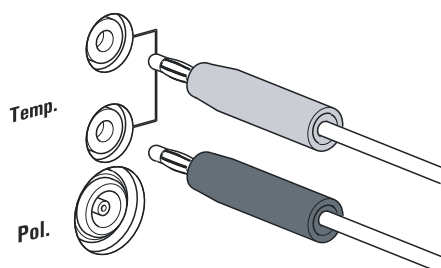

Figure 15 Connecting a temperature sensor or an electrode with integrated temperature sensor

**NOTE**

Always insert the red plug into the red socket. This is the only way that shielding against electrical interference can be ensured.

3.5.5 Connecting an iConnect

An external 854 iConnect measuring interface can be connected to the 905 Titrando.

Connect the iConnect as follows:

- 1 Plug the iConnect plug into the **iConnect** socket of the 905 Titrando.



Take care to ensure that the marking on the plug matches the marking on the Titrando as shown in the figure.

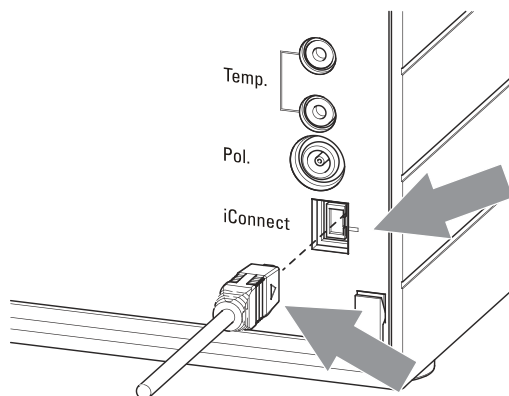

Figure 16 Connecting the iConnect

The iConnect is detected automatically and entered as measuring input into the device properties of the Titrando. If an electrode is connected to the iConnect that is not yet included in the list of sensors for the control software, then a corresponding message will be displayed.

The iConnect can be plugged in and unplugged while the Titrando is switched on.

An electrode with integrated data chip, referred to as iTrode, is connected to the iConnect.

Connect the electrode as follows:

- 1 Remove the protective caps on the iConnect and the electrode.
- 2 Plug in the electrode on the iConnect as illustrated below.

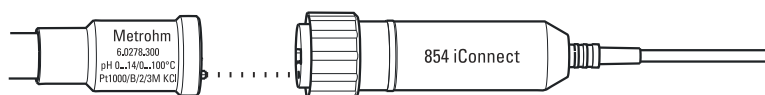

Figure 17 Connecting an electrode to the iConnect

The guide pin guarantees correct connection in such a way that the contact pins cannot be damaged.

- 3 Screw the iConnect tightly.

3.5.6 Differential potentiometry

Potentiometric measurements with high-ohm measuring chains can be disrupted by electrostatic and electromagnetic fields in media with low conductivity. Use our 6.0229.100 Solvotrode or other special electrodes for pH measurements in organic solvents. If no reliable measurements are possible with these, then a 6.5104.030 (230 V) or 6.5104.040 (115 V) differential amplifier can be used. The differential amplifier is connected to the high-ohm measuring input (**Ind.**).

5 Operation and maintenance

5.1 General notes

5.1.1 Care

The 905 Titrande requires appropriate care. Excess contamination of the instrument may result in functional disruptions and a reduction in the life-time of the otherwise sturdy mechanics and electronics.

Spilled chemicals and solvents should be removed immediately. Above all, the plug connections on the rear of the instrument (in particular the power socket) should be protected from contamination.



CAUTION

Although this is extensively prevented by design measures, the power plug should be unplugged immediately if aggressive media have penetrated the inside of the instrument, so as to avoid serious damage to the instrument electronics. In such cases, Metrohm Service must be informed.

5.1.2 Maintenance by Metrohm Service

Maintenance of the 905 Titrande is best carried out as part of an annual service, which is performed by specialist personnel of the Metrohm company. If working frequently with caustic and corrosive chemicals, a shorter maintenance interval could be necessary.

Metrohm Service offers every form of technical advice for maintenance and service of all Metrohm instruments.



5.2 Quality Management and qualification with Metrohm

Quality management

Metrohm offers you comprehensive support in implementing quality management measures for instruments and software. Further information on this can be found in the brochure "**Metrohm Quality Management**" available from your local Metrohm representative.

Qualification

Please contact your local Metrohm representative for support in qualification of instruments and software. The **Installation Qualification (IQ)** and **Operational Qualification (OQ)** are offered by Metrohm representatives as a service. They are carried out by trained employees using standardized qualification documents and in accordance with the currently applicable requirements of the regulated industry. Further information on this can be found in the brochure "**Analytical Instrument Qualification – Confidence in quality with IQ/OQ**".

Maintenance

The electronic and mechanical functional groups of Metrohm instruments can and should be checked by specialist personnel from Metrohm as part of a regular preventive maintenance schedule. Please ask your local Metrohm representative regarding the precise terms and conditions involved in concluding a corresponding maintenance agreement. Further information on this can be found in the brochure "**Metrohm Care Contracts – Protect your investment the smart way**" available from your local Metrohm representative.

6 Troubleshooting

6.1 General

Problem	Cause	Remedy
The "On" LED is not illuminated, even though the instrument is connected to the power supply.	<i>The Touch Control or the computer has not been switched on yet or the plugs are not correctly plugged in.</i>	<ol style="list-style-type: none"> 1. Check the plug connections. 2. Switch on the Touch Control or the computer.

6.2 SET titration

Problem	Cause	Remedy
The titration will not be finished.	<i>The minimum dosing rate is too low.</i>	Select the user-defined titration rate and increase the minimum rate (see manual/help of the software used).
	<i>The stop criterion is unsuitable.</i>	Adjust the control parameters (see manual/help of the software used): <ul style="list-style-type: none"> ▪ Increase the stop drift. ▪ Select a short delay time.
The sample is over-titrated.	<i>The control parameters are unsuitable.</i>	Adjust the control parameters (see manual/help of the software used): <ul style="list-style-type: none"> ▪ Select Titration rate = slow. ▪ Select the user-defined titration rate and increase the control range. ▪ Select the user-defined titration rate and reduce the maximum rate. ▪ Select the user-defined titration rate and reduce the minimum rate. ▪ Stir faster. ▪ Arrange the electrode and buret tip to an optimum.
	<i>The electrode responds too slowly.</i>	Replace the electrode.
The titration time is too long.	<i>The control parameters are unsuitable.</i>	Adjust the control parameters (see manual/help of the software used): <ul style="list-style-type: none"> ▪ Select Titration rate = optimal or fast.



Problem	Cause	Remedy
		<ul style="list-style-type: none">▪ Select the user-defined titration rate and decrease the control range.▪ Select the user-defined titration rate and increase the maximum rate.▪ Select the user-defined titration rate and increase the minimum rate.
The results are spread widely.	<i>The minimum dosing rate is too high.</i>	Select user-defined titration rate and decrease the minimum rate (see manual/help of the software used).
	<i>The electrode responds too slowly.</i>	Replace the electrode.

7 Appendix

7.1 Remote interface

The 6.2148.010 Remote Box allows devices to be controlled which cannot be connected directly to the MSB interface of the Titrando.

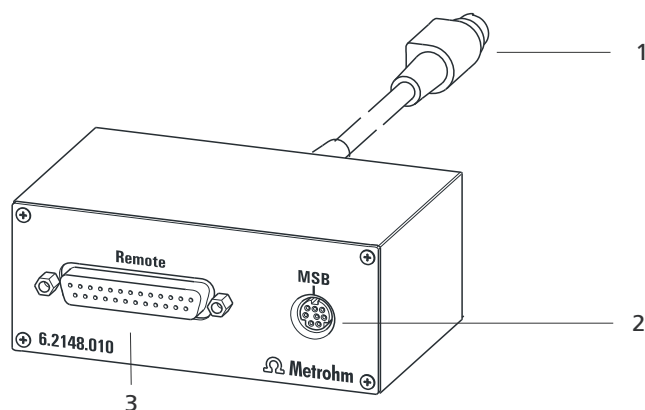

Figure 19 Connectors of the Remote Box

1 Cable

For connecting to the Titrando.

2 MSB connector

Metrohm Serial Bus. For connecting external dosing devices or stirrers.

3 Remote connector

For connecting instruments with a remote interface.

7.1.1 Pin assignment of the remote interface

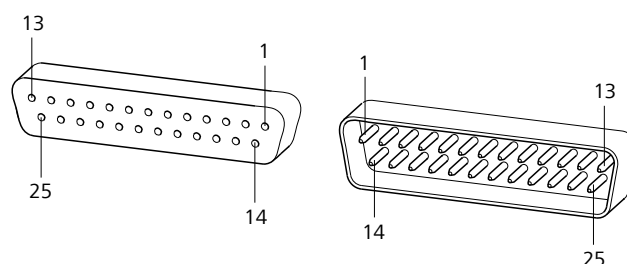
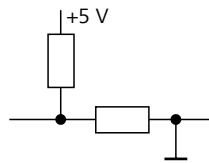

Figure 20 Pin assignment of remote socket and remote plug

The above figure of the pin assignment applies for all Metrohm instruments with 25-pin D-Sub remote connector.



Inputs



approx. 50 k Ω Pull-up

$t_p > 20$ ms

active = low, inactive = high

Outputs

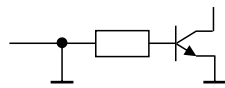

Open Collector

$t_p > 200$ ms

active = low, inactive = high

$I_C = 20$ mA, $V_{CEO} = 40$ V

+5 V: maximum load = 20 mA

The following tables offer information concerning the assignment of the individual pins and their function:

Table 1 Inputs and outputs of the remote interface

Assignment	Pin No.	Function*
Input 0	21	Start
Input 1	9	Stop
Input 2	22	
Input 3	10	Quit
Input 4	23	–
Input 5	11	
Input 6	24	
Input 7	12	
Output 0	5	Ready
Output 1	18	Conditioning OK
Output 2	4	Determination
Output 3	17	EOD
Output 4	3	
Output 5	16	Error
Output 6	1	
Output 7	2	Warning

Assignment	Pin No.	Function*
Output 8	6	
Output 9	7	
Output 10	8	
Output 11	13	
Output 12	19	
Output 13	20	
0 volts / GND	14	
+5 volts	15	
0 volts / GND	25	

* Signal activated only for operation with Touch Control.

Table 2 Explanation of the individual functions

Function	Explanation
Start	The current method is started at the time of activation. $t_{\text{pulse}} > 100 \text{ ms}$
Stop	The current method is canceled (Stop) at the time of activation. $t_{\text{pulse}} > 100 \text{ ms}$
Quit	The current command in the determination run will be canceled at the time of activation. $t_{\text{pulse}} > 100 \text{ ms}$
Ready	The instrument is ready to receive a start signal.
Conditioning OK	The line is set when Conditioning with SET titration and KFT titration is at OK. The line remains set until the determination is started with [START] .
Determination	The instrument performs a data-generating determination.
EOD	End of Determination. Pulse ($t_{\text{pulse}} = 200 \text{ ms}$) after a determination or after a buffer/standard solution during calibration using a Sample Processor.
Error	The line is set for error message display.



Function	Explanation
Warning	The line is set for warning message display.

8 Technical specifications

8.1 Measuring interface

Depending on the version, the 905 Titrande has one (version 2.905.0010) or two (version 2.905.0020) galvanically isolated measuring interface(s).

The measuring cycle is 100 ms for all measuring modes.

8.1.1 Potentiometry

One high-ohm measuring input (**Ind.**) for pH, metal or ion-selective electrodes and one measuring input (**Ref.**) for separate reference electrodes.

Input resistance $> 1 \cdot 10^{12} \Omega$

Offset current $< 1 \cdot 10^{-12} \text{ A}$ (under reference conditions)

Measuring mode
pH

Measuring range -13 - +20 pH

Resolution 0.001 pH

Measuring accuracy $\pm 0.003 \text{ pH}$
(± 1 digit, without sensor error, under reference conditions)

Measuring mode
U

Measuring range -1,200 - +1,200 mV

Resolution 0.1 mV

Measuring accuracy $\pm 0.2 \text{ mV}$
(± 1 digit, without sensor error, under reference conditions)

8.1.2 Temperature

A measuring input (**Temp.**) for temperature sensors of the Pt1000 or NTC type with automatic temperature compensation.

R (25 °C) and B value can be configured for NTC sensors.

Measuring range

Pt1000 -150 - +250 °C

NTC -5 - +250 °C

(R (25 °C) = 30,000 Ω and B (25/50) = 4,100 K)

*Resolution*

Pt1000 0.1 °C

NTC 0.1 °C

Measuring accuracy

Pt1000 ±0.2 °C
(Applies for measuring range -20 - +150 °C; ±1 digit; without sensor error, under reference conditions)

NTC ±0.6 °C
(Applies for measuring range +10 - +40 °C; ±1 digit; without sensor error, under reference conditions)

8.1.3 Polarizer

One measuring input (**Pol.**) for polarizable electrodes.

*Measuring mode
I_{pol}*

Determination with adjustable polarization current

Polarization current -122.5 - +122.5 µA (increment: 0.5 µA)
-125.0 - +125.0 µA: non-guaranteed values, dependent on reference voltage +2.5 V

Measuring range -1,200 - +1,200 mV

Resolution 0.1 mV

Measuring accuracy ±0.2 mV
(±1 digit, without sensor error, under reference conditions)

*Measuring mode
U_{pol}*

Determination with adjustable polarization voltage

Polarization voltage -1,225 - +1,225 mV (increment: 25 mV)
-1,250 - +1,250 mV: non-guaranteed values, dependent on reference voltage +2.5 V

Measuring range -120 - +120 µA

Resolution 0.1 µA

8.2 Power connection

<i>Supply voltage</i>	100 - 240 V
<i>Frequency</i>	50 - 60 Hz
<i>Power consumption</i>	Maximum 45 W
<i>Fuse</i>	Electronic overload protection

8.3 Safety specifications

<i>Design and testing</i>	<ul style="list-style-type: none"> ▪ EN/IEC 61010-1 ▪ UL 61010-1 ▪ CSA-C22.2 No. 61010-1 ▪ Protection class I
<i>Safety instructions</i>	The documentation contains safety instructions which have to be followed by the user in order to ensure safe operation of the instrument.

8.4 Electromagnetic compatibility (EMC)

<i>Emission</i>	Standards fulfilled: <ul style="list-style-type: none"> ▪ EN/IEC 61326-1 ▪ EN/IEC 61000-6-3 ▪ EN 55022 / CISPR 22
<i>Immunity</i>	Standards fulfilled: <ul style="list-style-type: none"> ▪ EN/IEC 61326-1 ▪ EN/IEC 61000-6-2 ▪ EN/IEC 61000-4-2 ▪ EN/IEC 61000-4-3 ▪ EN/IEC 61000-4-4 ▪ EN/IEC 61000-4-5 ▪ EN/IEC 61000-4-6 ▪ EN/IEC 61000-4-11 ▪ EN/IEC 61000-4-14 ▪ NAMUR



8.5 Ambient temperature

<i>Nominal function range</i>	+5 - +45 °C
<i>Storage</i>	-20 - +60 °C
<i>Transport</i>	-40 - +60 °C

8.6 Reference conditions

<i>Ambient temperature</i>	+25 °C (± 3 °C)
<i>Relative humidity</i>	≤ 60%
<i>Instrument status</i>	Instrument in operation at least 30 min
<i>Adjusting interval</i>	annual

8.7 Dimensions

<i>Width</i>	142 mm
<i>Height</i>	227 mm
<i>Depth</i>	231 mm
<i>Weight</i>	2,817 g
<i>Material (housing)</i>	Poly(butylene terephthalate) (PBT)

8.8 Interfaces

USB connectors

USB ports 2 USB downstream ports (type A sockets), 500 mA each, for connecting peripheral devices such as printers, keyboards, barcode readers or RS-232/USB boxes (Metrohm order no. 6.2148.020).

Connector "Controller"

Controller port USB upstream port with auxiliary power supply (Mini DIN socket) for connecting Touch Control or computer for controlling the 905 Titrande.

Touch Control With integrated Touch Control cable.

Computer With 6.2151.000 cable.

**MSB connectors (Metrohm Serial Bus)**

<i>Dosing device</i>	Connection for a maximum of 4 external dosing devices, models Dosi-mat or Dosino (MSB 1 to MSB 4).
<i>Stirrer</i>	Connection for a maximum of 4 stirrers. Stirrer control: switching on/off manually or coordinated with the titra-tion sequence. Speed in 15 steps and shift direction can be selected.
<i>Remote Box</i>	Connection for a maximum of four Remote Boxes. Remote Boxes can be used to actuate and monitor external devices.



9 Warranty (guarantee)

Metrohm guarantees that the deliveries and services it provides are free of defects in materials, design or manufacturing.

The general warranty period is 36 months (exclusions below) from the date of delivery or 18 months in the event of continuous operation. The warranty remains valid on the condition that the servicing is provided by a service organization authorized by Metrohm at defined intervals and with a defined scope.

The warranty period for anion suppressors of the type "MSM" is 120 months from the date of delivery or 60 months in the case of continuous operation.

The warranty period for IC separation columns is 90 days after start-up.

For third-party components that are recognizable as such, the manufacturer's warranty regulations apply.

Consumables and materials with limited storage life and glass breakage in the case of electrodes or other glass parts are excluded from the warranty.

Warranty claims cannot be asserted if the ordering party has failed to meet its payment obligations according to schedule.

During the warranty period, Metrohm undertakes either to replace free of charge or to credit the purchaser for any modules or components that can be shown to be faulty. Any transport or customs fees that may apply are the ordering party's responsibility.

The precondition for this is that the ordering party has to specify the article number, the article designation, an adequate error description, the delivery date and (if applicable) the serial number or chip data in the Support Tracker. Metrohm then decides whether a replacement or a credit note is to be issued or whether the faulty part has to be returned using the Return Material Authorization (RMA). If a replacement or credit note is issued, the ordering party undertakes to store the faulty part for at least 24 months in accordance with the current storage directives (in compliance with ESD guidelines) and to hold it in readiness for onsite inspection or for return shipment to Metrohm. Metrohm reserves the right to invoice the ordering party for these articles, including retroactively, in the event of noncompliance with these preconditions.

The same warranty periods that are specified for a corresponding new part apply to parts that are replaced or repaired within the above-mentioned warranty periods. However, replacement or repair of a part does not extend the warranty period of the entire system.

Deficiencies arising from circumstances that are not the responsibility of Metrohm, such as improper storage or improper use, etc., are expressly excluded from the warranty.

Metrohm also offers a 120 month spare parts availability guarantee and a 60 month PC software support warranty, calculated from the date on which the product is withdrawn from the market. The content of this warranty is the ability of the customer to obtain functioning spare parts or appropriate software support at market prices during the time of the warranty period.

If Metrohm AG is unable to meet this obligation due to circumstances beyond the control of Metrohm AG, then the ordering party shall be offered alternative solutions at preferential conditions.



10 Accessories





NOTE

Subject to change without notice.

10.1 Scope of delivery

10.1.1 2.905.0010

Qty.	Order no.	Description	
1	1.905.0010	Titrande High-end titrator for use of intelligent electrodes "iTrodes". Up to four 800 Dosino dosing systems. Dynamic (DET), monotonic (MET) and endpoint titration (SET). Measurements with ion-sensitive electrodes (MEAS CONC). Dosing functions (DOS), Liquid Handling. Four MSB connections. One galvanically separated measuring interface. USB connection.	
2	6.2043.005	Holding clip for bottles Holding spring for reagent bottles in exchange units.	
1	6.2103.130	Adapter red 2 mm plug / 4 mm socket For connecting plug B (4 mm) to 2 mm socket.	

Qty.	Order no.	Description
------	-----------	-------------

1 6.2103.140 Adapter black 2 mm plug / B socket 4 mm

For connecting plug B (4 mm) to 2 mm socket.



Qty.	Order no.	Description
------	-----------	-------------

1 6.2122.0x0 Power supply cable with IEC 60320 line socket, type C13

Cable plug according to customer requirements.

Switzerland: SEV 1011, Type 12
6.2122.020

Germany, ...: CEE 7, Type VII
6.2122.040

USA, ...: NEMA 5-15, Type 498
6.2122.070

Length: 1.5 m

Qty.	Order no.	Description
------	-----------	-------------

1 8.905.8003EN 905 Titrande Manual

10.1.2 2.905.0020

Qty.	Order no.	Description
------	-----------	-------------

1 1.905.0020 Titrande



High-end titrator for use of intelligent electrodes "iTrodes". Up to four 800 Dosino dosing systems. Dynamic (DET), monotonic (MET) and endpoint titration (SET). Measurements with ion-sensitive electrodes (MEAS CONC). Dosing functions (DOS), Liquid Handling. Four MSB connections. Two galvanically separated measuring interfaces. USB connection.



Qty.	Order no.	Description	
2	6.2043.005	Holding clip for bottles Holding spring for reagent bottles in exchange units.	
2	6.2103.130	Adapter red 2 mm plug / 4 mm socket For connecting plug B (4 mm) to 2 mm socket.	
2	6.2103.140	Adapter black 2 mm plug / B socket 4 mm For connecting plug B (4 mm) to 2 mm socket.	
1	6.2122.0x0	Power supply cable with IEC 60320 line socket, type C13 Cable plug according to customer requirements. Switzerland: SEV 1011, Type 12 6.2122.020 Germany, ...: CEE 7, Type VII 6.2122.040 USA, ...: NEMA 5-15, Type 498 6.2122.070 Length: 1.5 m	
1	8.905.8003EN	905 Titrand Manual	

10.2 Optional accessories

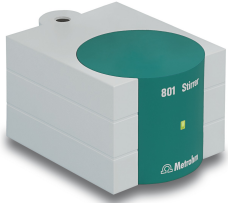
10.2.1 2.905.0010 and 2.905.0020

Order no.	Description	
2.800.0010	800 Dosino	
	Drive with write/read hardware for intelligent Dosing Units. With fixed cable (length 150 cm).	
2.801.0040	801 Stirrer with stand	
	Magnetic stirrer including base plate, support rod and electrode holder for supplementing the Titrino plus, Dosimat plus, Titrandos, Sample Processors, 805 Dosimat and 780/781 pH meters as well as the 856 and 867 measuring modules. With permanently attached cable for MSB (Metrohm Serial Bus).	
2.802.0040	802 Stirrer (propeller stirrer) for 804 Ti Stand	
	Rod stirrer with 6.1909.010 Propeller stirrer.	



Order no.	Description
-----------	-------------

2.804.0040	804 Ti Stand with stand
-------------------	--------------------------------

Titration stand and controller for 802 Rod Stirrer. The 804 Ti Stand together with the optional 802 Rod Stirrer provides an alternative to the magnetic stirrer. Ti Stand with base plate, support rod and electrode holder.



2.805.0010	805 Dosimat
-------------------	--------------------

Dosing device for the Titrando and Sample Processors with read/write hardware for intelligent Exchange Units. With permanently attached cable. Without Exchange Unit.



Order no.	Description
-----------	-------------

2.846.0010	846 Dosing Interface
-------------------	-----------------------------

USB controller for up to four 700/800 Dosino dosing systems or 685/805 Dosimats for dosing or liquid handling tasks. A Touch Control control unit or the connection to a PC with tiamo™, MagIC Net™ or 797 VA Computrace is required.



6.2104.020	Electrode cable / 1 m / F
-------------------	----------------------------------

For connecting electrodes with Metrohm plug-in head G to Metrohm instruments (socket F).

Length (m): 1



6.2104.600	Electrode cable for plug in head U/plug F, 2x2 mm B, 1m
-------------------	--

For connecting electrodes with Metrohm plug-in head U to Metrohm instruments (socket F).

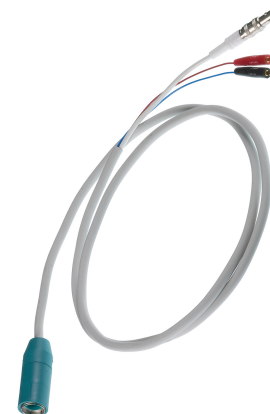



Order no.	Description
-----------	-------------

6.2148.010 Remote Box MSB

Additional remote interface for the connection of devices that can be controlled via remote lines. With permanently attached cable.



6.2148.020 RS-232/USB box

Extends the Titrande, USB Sample Processors, Dosing Interface, Titrosampler by two RS-232 interfaces for connecting e.g. balances, PC, LIMS. Requires 6.2151.030 cable.



6.3026.110 Exchange Unit 1 mL

Exchange Unit with integrated data chip with 1 mL glass cylinder and light protection. PCTFE/PTFE flat stopcock, FEP tubing connection, antidiffusion buret tip and standard amber glass reagent bottle.

Volume (mL): 1



6.3026.150 Exchange Unit 5 mL

Exchange Unit with integrated data chip with 5 mL glass cylinder and light protection. PCTFE/PTFE flat stopcock, FEP tubing connection, anti-diffusion buret tip and standard amber glass reagent bottle.

Volume (mL): 5



Order no.	Description
-----------	-------------

6.3026.210 Exchange Unit 10 mL

Exchange unit with integrated data chip with 10 mL glass cylinder and light protection. PCTFE/PTFE flat stopcock, FEP tubing connection, anti-diffusion buret tip and standard amber glass reagent bottle.

Volume (mL): 10

6.3026.220 Exchange Unit 20 mL

Exchange unit with integrated data chip with 20 mL glass cylinder and light protection. PCTFE/PTFE flat stopcock, FEP tubing connection, anti-diffusion buret tip and standard amber glass reagent bottle.





Volume (mL): 20

6.3026.250 Exchange Unit 50 mL

Exchange unit with integrated data chip with 50 mL glass cylinder and light protection. PCTFE/PTFE flat stopcock, FEP tubing connection, anti-diffusion buret tip and standard amber glass reagent bottle.

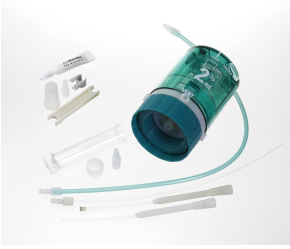
Volume (mL): 50



Order no.	Description	
6.3032.120	Dosing Unit 2 mL	
<p data-bbox="188 286 1075 385">Dosing unit with integrated data chip with 2 mL glass cylinder and light protection, mountable on reagent bottle with ISO/DIN GL45 glass thread. FEP tubing connection, anti-diffusion buret tip.</p> <p data-bbox="188 394 1075 430">Volume (mL): 2</p>		
6.3032.150		Dosing Unit 5 mL
<p data-bbox="188 797 1075 887">Dosing unit with integrated data chip with 5 mL glass cylinder and light protection, mountable on reagent bottle with ISO/DIN GL45 thread. FEP tubing connection, anti-diffusion buret tip.</p> <p data-bbox="188 896 1075 940">Volume (mL): 5</p>		
6.3032.210		Dosing Unit 10 mL
<p data-bbox="188 1308 1075 1397">Dosing unit with integrated data chip with 10 mL glass cylinder and light protection, mountable on reagent bottle with ISO/DIN GL45 thread. FEP tubing connection, anti-diffusion buret tip.</p> <p data-bbox="188 1406 1075 1451">Volume (mL): 10</p>		
6.3032.220		Dosing Unit 20 mL
<p data-bbox="188 1505 1075 1594">Dosing unit with integrated data chip with 20 mL glass cylinder and light protection, mountable on reagent bottle with ISO/DIN GL45 thread. FEP tubing connection, anti-diffusion buret tip.</p> <p data-bbox="188 1603 1075 1648">Volume (mL): 20</p>		
6.3032.250		Dosing Unit 50 mL
<p data-bbox="188 2024 1075 2114">Dosing unit with integrated data chip with 50 mL glass cylinder and light protection, mountable on reagent bottle with ISO/DIN GL45 thread. FEP tubing connection, anti-diffusion buret tip.</p> <p data-bbox="188 2123 1075 2168">Volume (mL): 50</p>		

Order no.	Description
-----------	-------------

2.900.0010 900 Touch Control

Operating unit for the Titrados, USB Sample Processors, 856 Conductivity Module, 867 pH Module and 846 Dosing Interface. Touch-sensitive, high-resolution color display, simple and intuitive operation, thanks to favorites for direct method access. With integrated Ethernet interface for direct connection to the Internet and USB interface for connecting USB printers or a USB memory stick.

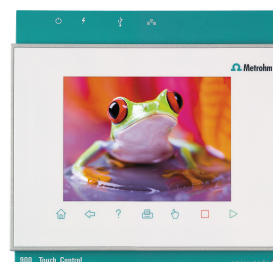

2.854.0010 854 iConnect

854 iConnect - electrode cable and measuring amplifier for intelligent electrodes "iTrodes".



6.6056.231 tiamo™ 2.3 Light CD: 1 license

tiamo™ 2.3 light computer program for controlling a titration system. Up to two instruments can be connected. Graphical method editor with numerous templates. Layout Manager for customizing the user interface. Professional database with reevaluation. High-performance report generator. No parallel titration, no data export. 1 license. Dialog languages: German, English.

6.6056.232 tiamo™ 2.3 Full CD: 1 license

computer program for controlling complex titration systems.

6.6056.233 tiamo™ 2.3 Multi CD: 3 licenses

Client/server-compatible computer program for controlling complex titration systems.



Index

Numbers/Symbols

6.2151.000 controller cable	12
685 Dosimat	15
700 Dosino	15
800 Dosino	15
801 Stirrer	16
803 Ti Stand	16
804 Ti Stand	16
805 Dosimat	15

A

ADD	4
-----	---

B

Balance	20
Barcode reader	
Connect	22

C

Calibration mode	
CAL	4
Computer	
Connect	12
Connect	
Balance	20
Barcode reader	22
Computer	12
Dosing device	15
iConnect	25
MSB devices	14
PC keyboard	21
Printer	19
Remote Box	17
Stirrer	16
Titration stand	16
Touch Control	11
USB hub	19

Connector

MSB	2
USB	2
Controller	
Connector	9

D

DET	3
Device software	
Update	2
Differential potentiometry	27
Dosing command	3
ADD	4

EMPTY	4
LQH	4
PREP	4

Dosing device

Connect	15
---------	----

Driver software

Install	12
---------	----

E

Electrode	
Connect	23
Electrode test	
ELT	4
Electrostatic charge	7
EMPTY	4

G

GLP	30
Guarantee	42

I

iConnect	
Connect	25
Installation	
Driver software	12
Instrument description	2
Instrument type	9

K

Keyboard	
Connect	21

L

LED	
On	31
LQH	4

M

Mains voltage	6
Maintenance	29
Maintenance Agreement	30
MEAS	4
Measuring interface	2, 9
Measuring mode	3
MEAS	4
STDADD	4
MET	3
Metrohm Serial Bus MSB, see also "MSB"	14

MSB

Connect devices	14
Connector	9
MSB connector	2

O

Overview of the instrument	8
----------------------------	---

P

PC keyboard	
Connect	21
Pin assignment	33
Power connection	9
PREP	4
Printer	19

Q

Quality Management	30
--------------------	----

R

Remote	
Interface	33
Pin assignment	33
Remote Box	
Connect	17

S

Safety instructions	6
Sensor	
Connect	23
Serial number	9
Service	6
SET	3
STDADD	4
Stirrer	
Connect	16
Stirring direction	28
System test	11

T

Temperature sensor	
Connect	23
Titrand system	1
Titration mode	3
DET	3
MET	3
SET	3
Titration stand	
Connect	16



Titration vessel
 Equipping 28
Touch Control
 Connect 11

U

Update
 Device software 2

USB
 Connector 9
 USB connector 2
 USB hub
 Connect 19

V

Validation 30

W

Warranty 42